

# Norm 03

## Assembly Instructions

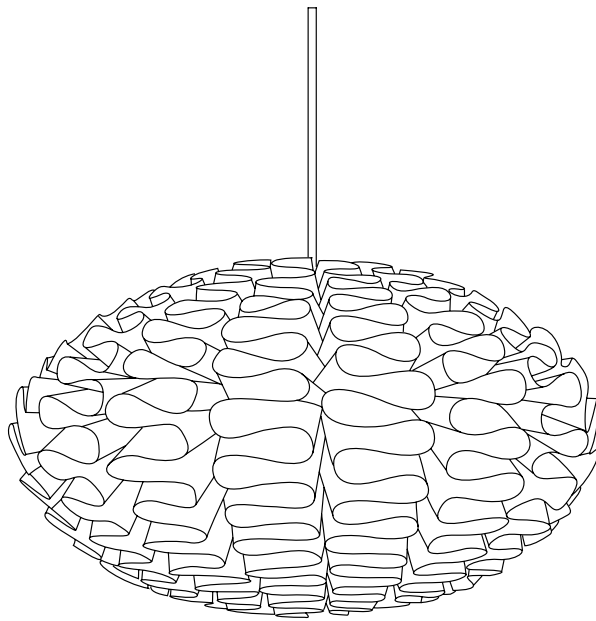

**normann**

C O P E N H A G E N

# 1 Indhold:

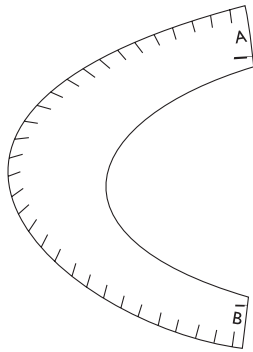

18 sideelementer

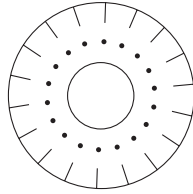

1 topmodul

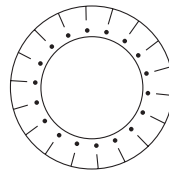

1 bundmodul

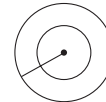

1 ophængsmodul

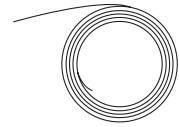

1 rulle = 18 strimler



strimmel med 31 mærker

## Samleinstruktion:

1.

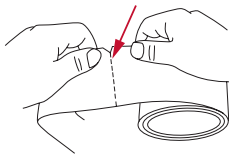

Tag rullen med strimler ud af æsken. Rul ud og afriv den første strimmel ved den stiplede linie.

2.

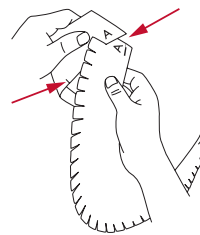

Påfør strimmel på sideelement. Vær opmærksom på at både strimmel og sideelement har top og bund. A = top, B = bund. Strimmel føres ved første afmærkning ind i sideelementets første slids.

3.

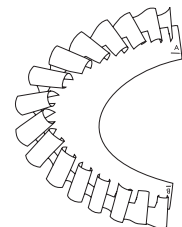
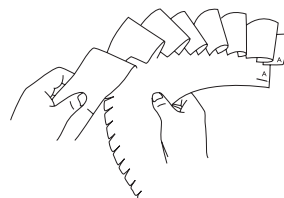
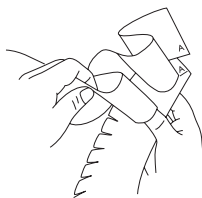

Før næste afmærkning ind i næste slids.  
Fortsæt nu på samme måde i alt 31 slidses.

**normann**

C O P E N H A G E N

**2**

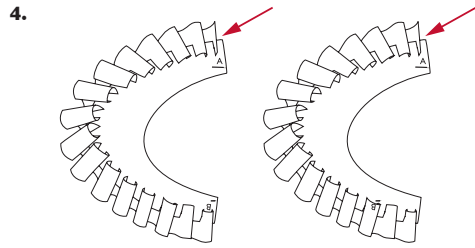

Gentag med 2. strimmel og 2. sideelement. Husk at starte påføringen af sideelement fra samme side. Fortsæt på samme måde med at påføre strimler på sideelementerne. I alt 18 stk.

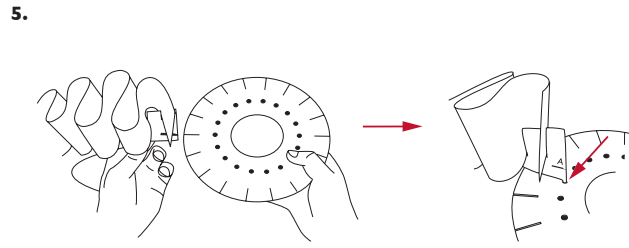

Tag topmodul og påfør sideelement. Slids mod slids. Sideelementet låses fast på topmodulet ved hjælp af den lille slip, der klikkes ned i hullet.

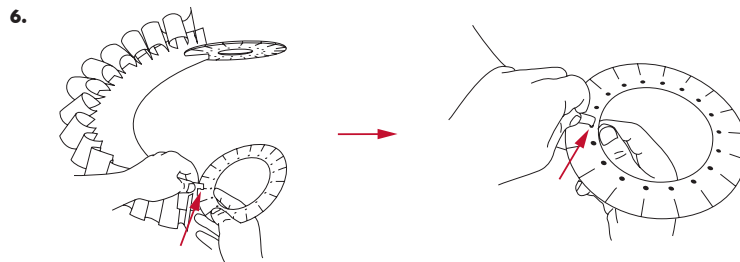

Tag bundmodul og påfør sideelement. Slids mod slids. Sideelementet låses fast på bundmodulet ved hjælp af den lille slip, der klikkes ned i hullet.

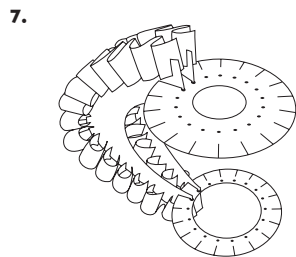

To sideelementer fastgjort på top- og bundmodul.

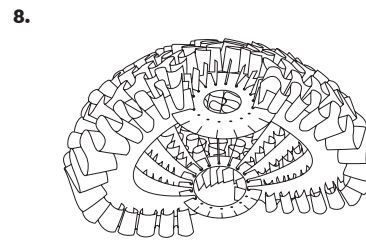

Halvdelen af sideelementerne fastgjort på top- og bundmodul. Fortsæt til alle 18 sideelementer er påsat.

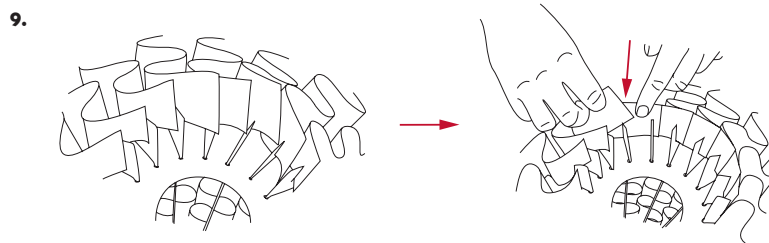

I toppen og bunden af lampen rettes alle strimlerne på plads ved at fastgøre toppen af strimlen i sideelementet ved siden af. Til sidst dannes der en pæn stabil kant i toppen og bunden af lampen.

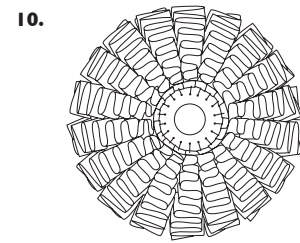

Samlet lampe set fra oven.

**3** 11.

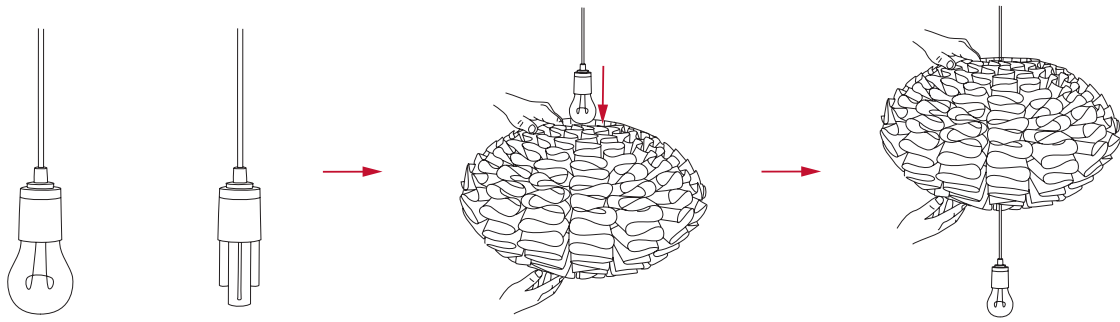

Ledning med fatning og pære føres fra toppen ned gennem lampen.

12.

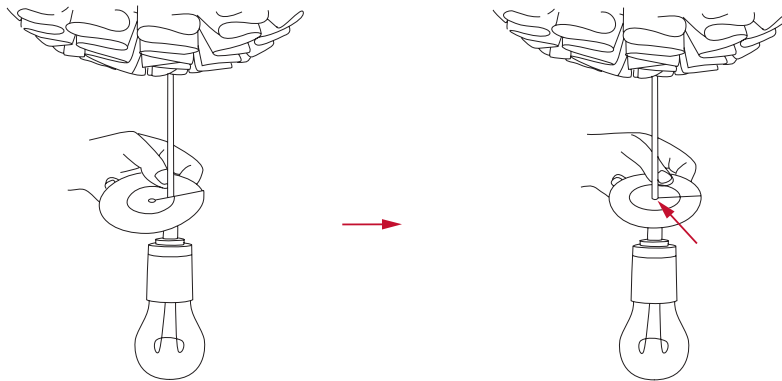

Når ledning med fatning og pære er ført gennem lampen, fastgøres ophængsmodulet på ledningen.

13.

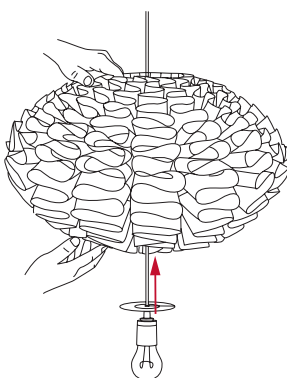

Træk nu det hele op gennem lampen, indtil ophængsmodulet hviler på topmodulet.

14.

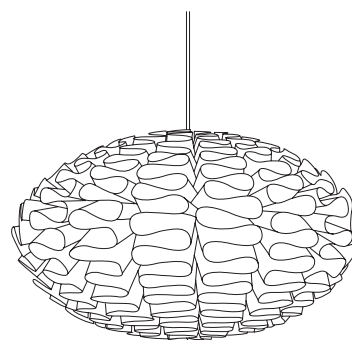

Færdig lampe. Klar til ophæng. **Max 60 watt.**

## 4 Innehåll:

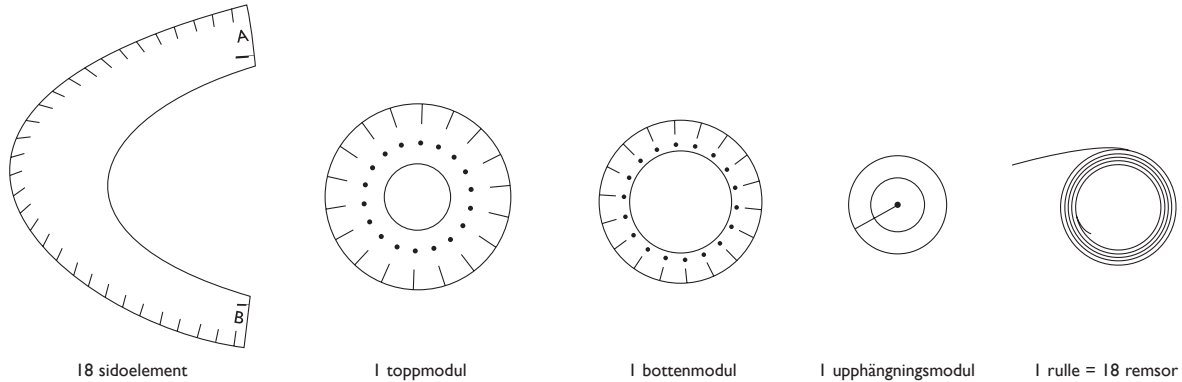

remsa med 31 markeringar

### Monteringsanvisning:

1.

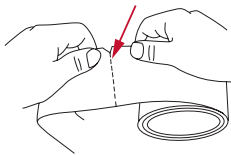

Ta ut rullen med remsor ur asken. Rulla ut den första remsan och riv av den vid den streckade linjen.

2.

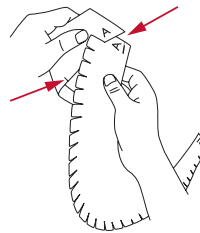

Fäst remsan på sidoelementet. Observera att både remsan och sidoelementet har topp och botten. A = topp, B = botten. Remsan förs in i sidoelementets första slits vid första markeringen.

3.

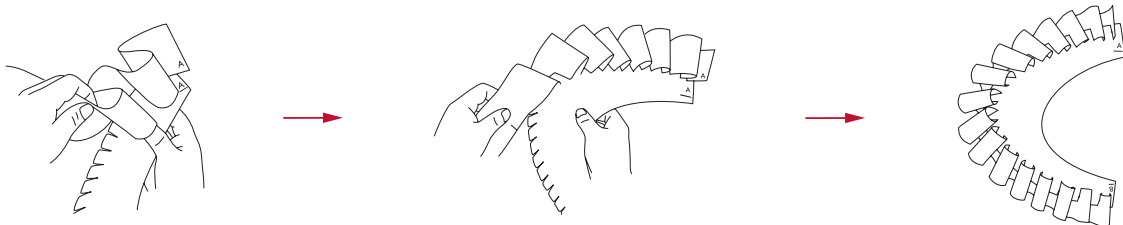

För in nästa markering i nästa slits. Gör likadant med alla 31 slitsarna.

**normann**

C O P E N H A G E N

# 5

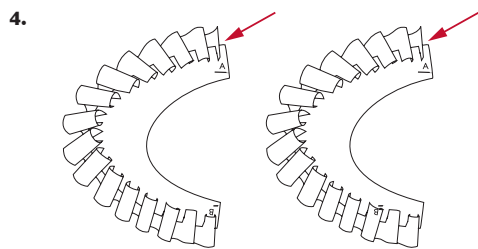

Upprepa igen med nästa remsa och sidoelement. Tänk på att börja arbetet med monteringen av sidoelementen från samma sida. Fortsätt fästa remсор på sidoelementen på samma sätt. Totalt 18 stycken.

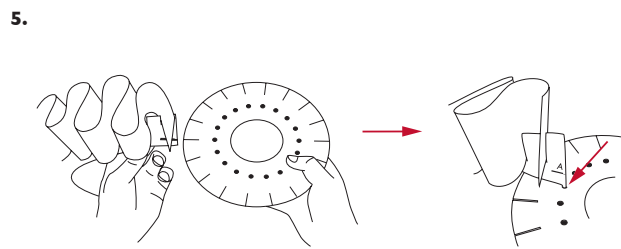

Ta fram toppmodulen och sätt fast sidoelementet. Slits mot slits. Sidoelementet läses fast på toppmodulen med hjälp av den lilla fliken, som klickas ner i hålet.

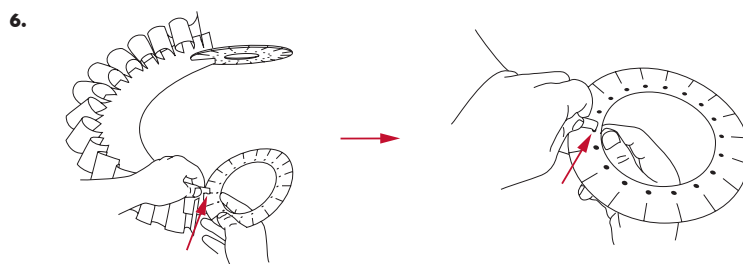

Ta fram bottenmodulen och sätt fast sidoelementet. Slits mot slits. Sidoelementet läses fast på bottenmodulen med hjälp av den lilla fliken, som klickas ner i hålet.

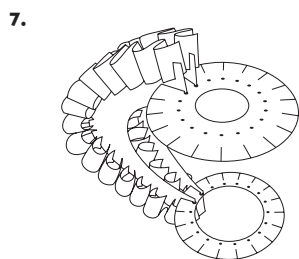

Två sidoelement som monterats på topp- och bottenmodulerna.

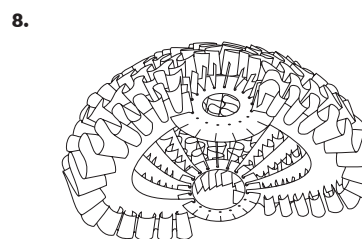

Hälften av sidoelementen monterade på topp- och bottenmodulerna. Fortsätt tills alla 18 sidoelementen har monterats.

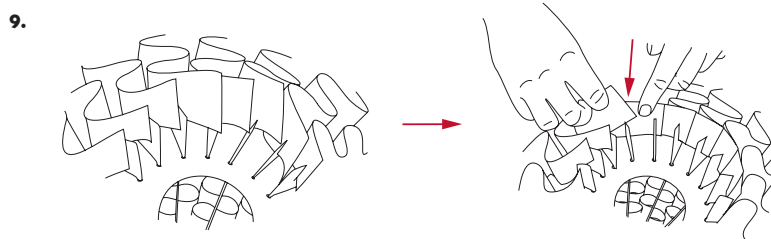

I lampans överdel och botten justeras alla remсорna på plats genom att fästa remsans överdel i sidoelementet intill. Gör till sist en snygg och stabil kant i lampans överdel.

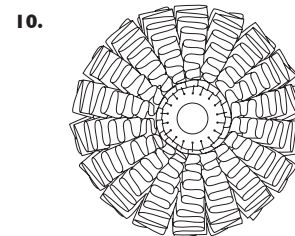

Färdigmonterad lampa ovanifrån.

6  
11.

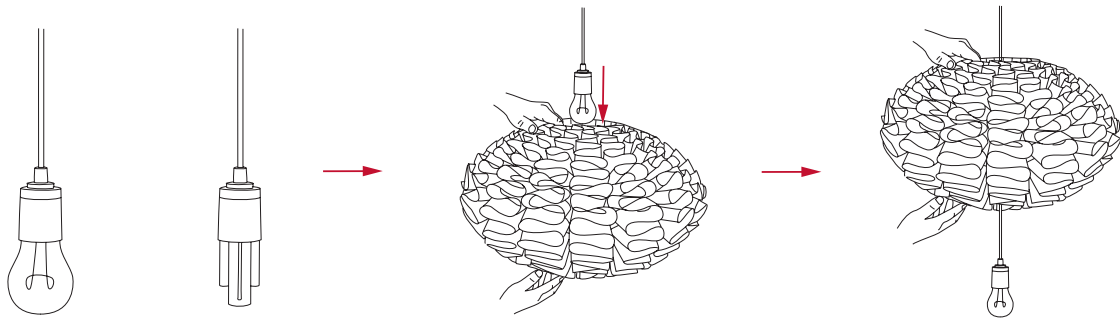

Ledningen med lamphållare och glödlampa förs in och genom lampan ovanifrån.

12.

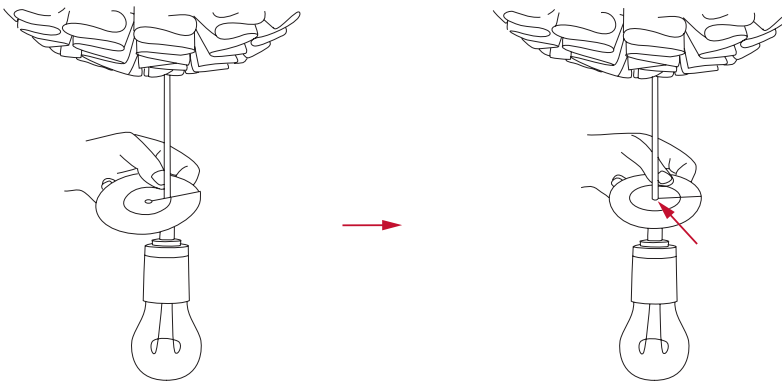

När ledningen med lamphållare och glödlampa har förts igenom lampan monteras upphängningsmodulen på ledningen.

13.

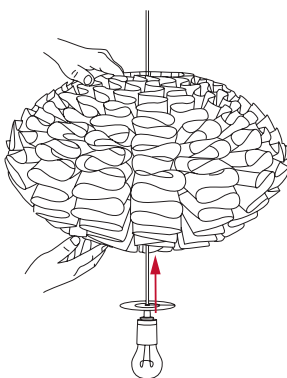

Dra nu upp det hela genom lampan, tills upphängningsmodulen vilar mot toppmodulen.

14.

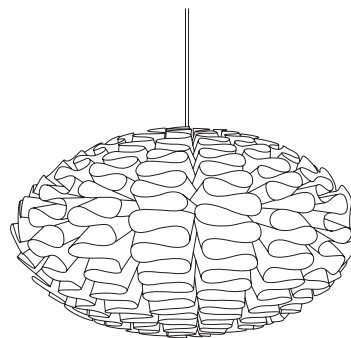

Lampan är färdig och klar att hängas upp. **Max 60 watt.**

**normann**

C O P E N H A G E N

## 7 Innhold:

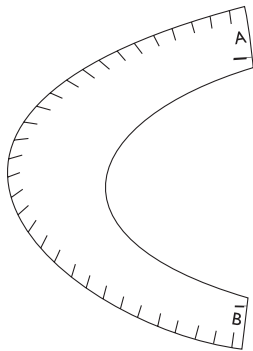

18 sideelementer

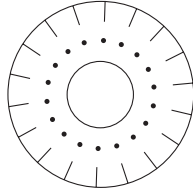

1 topmodul

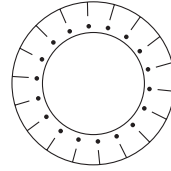

1 bunnd modul

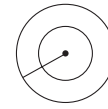

1 opphengsmødul

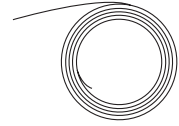

1 rull med 18 strimler



strimmel med 31 merker

### Instruksjon for sammensetting:

1.

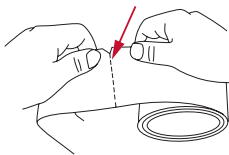

Ta rullen med strimlene ut av esken. Rull ut og riv av den første strimmelen ved den stiplede linjen.

2.

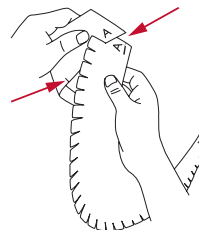

Sett strimmelen på sideelementet. Vær oppmerksom på at både strimmel og sideelement har topp og bunn. A = topp, B = bunn. Strimmelen føres ved første avmerking inn i sideelementets første spalte.

3.

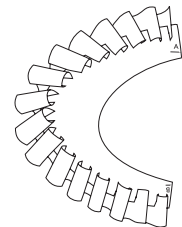
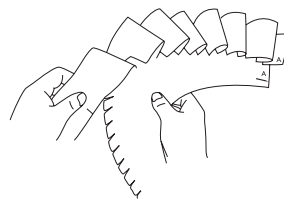
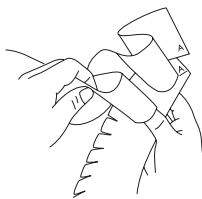

Før neste avmerking inn i neste spalte. Fortsett på samme måte. Det er 31 spalter til sammen.

**normann**

C O P E N H A G E N



**8**

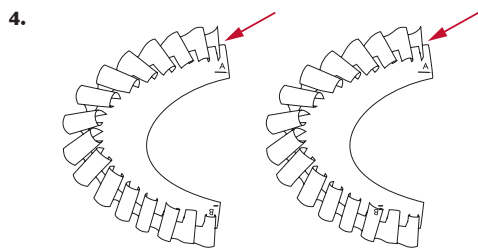

Gjenta med 2. strimmel og 2. sideelement. Husk å begynne påføringen av sideelementet fra samme side. Fortsett på samme måte med å påføre strimler på sideelementene. Det er 18 stk. til sammen.

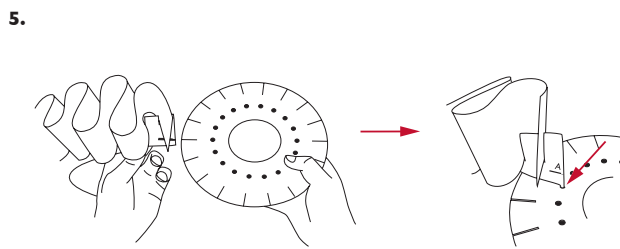

Ta toppmodulen og påfør sideelementet, spalte mot spalte. Sideelementet låses fast på toppmodulen ved hjelp av den lille slippen som klikkes ned i hullet.

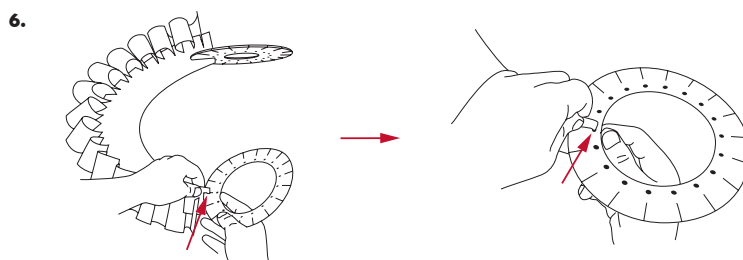

Ta bunnmodulen og påfør sideelementet, spalte mot spalte. Sideelementet låses fast på bunnmodulen ved hjelp av den lille slippen som klikkes ned i hullet.

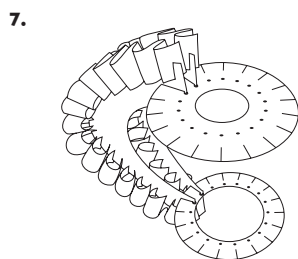

To sideelementer festet på topp- og bunnmodul.

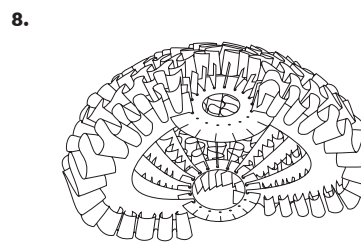

Halvdelen av sideelementene festet på topp- og bunnmodul. Fortsett til alle de 18 sideelementene er satt på.

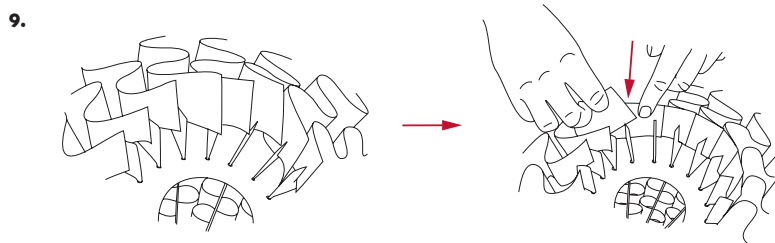

I toppen og bunnen av lampen rettes alle strimlene på plass ved å feste toppen av strimmelen i sideelementet ved siden av. Til slutt dannes en pen stabil kant på toppen av lampen.

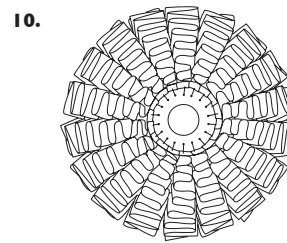

Sammensatt lampe sett ovenfra.

9  
11.

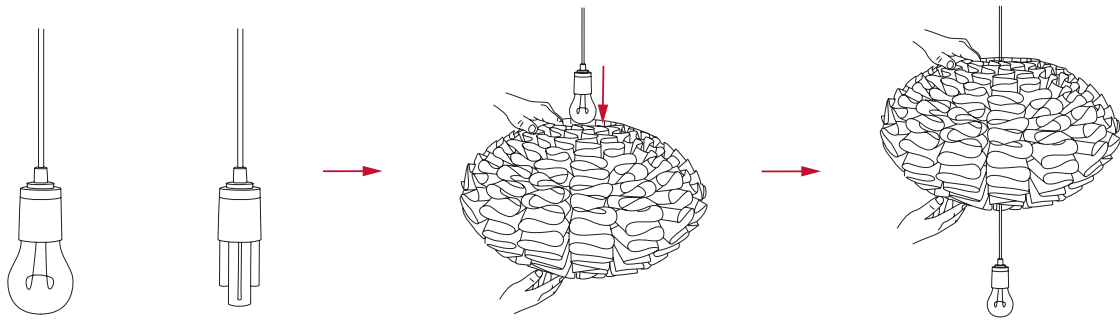

Ledning med fatning og pære føres fra toppen og ned gjennom lampen.

12.

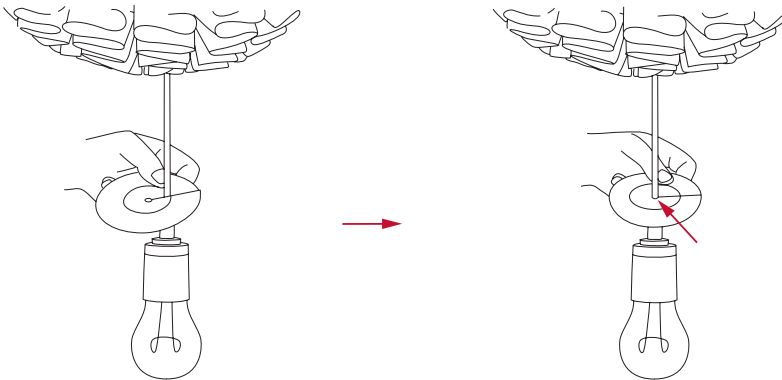

Når ledning med fatning og pære er ført gjennom lampen, festes opphengsmodulem på ledningen.

13.

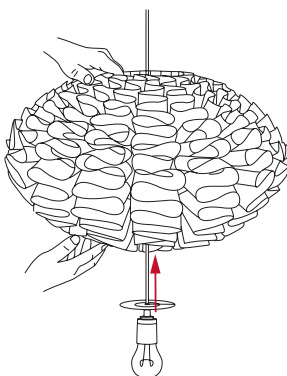

Trekk alt opp gjennom lampen til opphengsmodulem hviler på toppmodulem.

14.

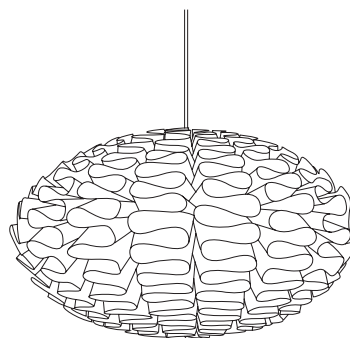

Ferdig lampe. Klar til å henges opp. **Maks 60 watt.**

**normann**

C O P E N H A G E N

# 10 Contents:

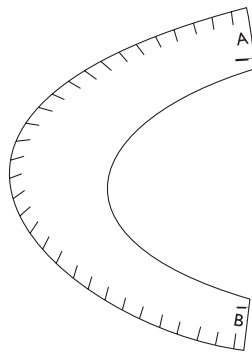

18 side elements

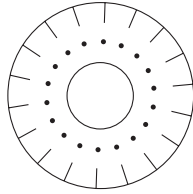

1 top module

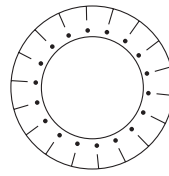

1 bottom module

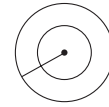

1 suspension piece

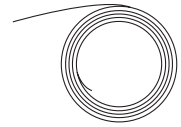

1 roll = 18 strips



strip with 31 marks

## Assembly instruction:

1.

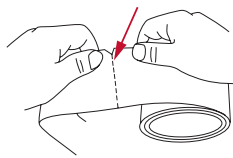

Take out the roll with strips. Roll out and tear off the first strip by the dotted line.

2.

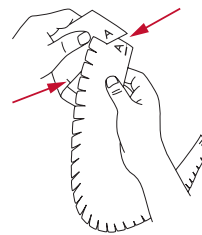

Insert the strip on the side element. Please note that both the strip and the side element have a top and a bottom. A: Top B = Bottom. Insert the strip at the first mark into the first slit of the side element.

3.

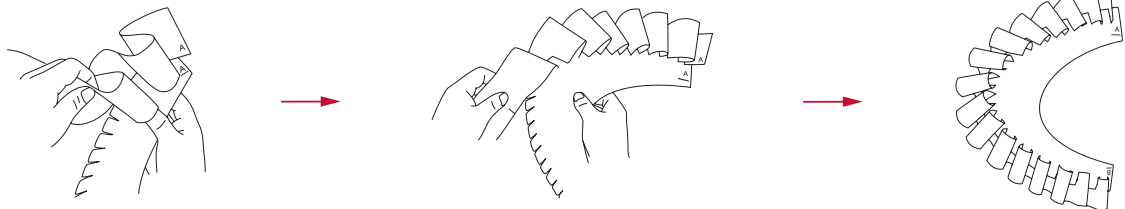

Insert the next mark into the next slit. Now continue exactly the same way with the remaining slits. 31 slits in total.

# 11

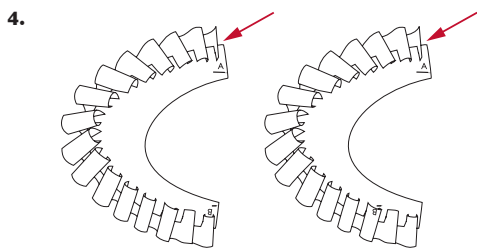

Repeat step 2 and step 3 with strip no. 2 and side module no. 2. Remember to begin each side module from the same side. Now continue exactly the same way by inserting all strips into the side modules. 18 side modules in total.

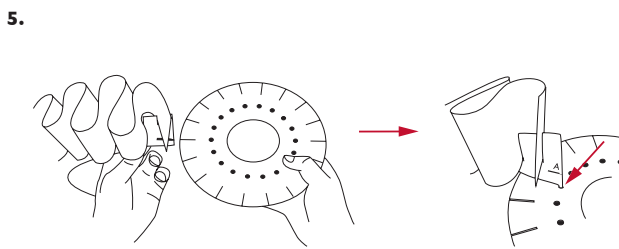

Take the top module and insert the completed side element. Slit against slit. The side element is secured to the top module by clicking the small slip down the hole.

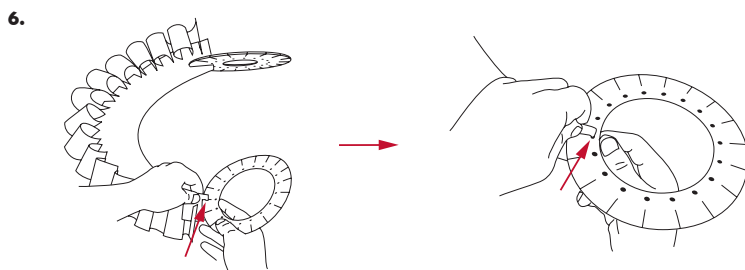

Take the bottom module and insert the completed side module. Slit against slit. The side element is secured to the bottom module by clicking the small slip down the hole.

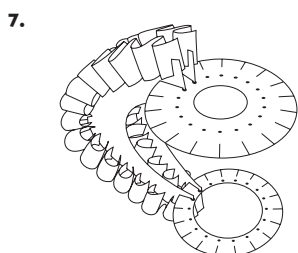

Two side elements secured to the top and bottom modules.

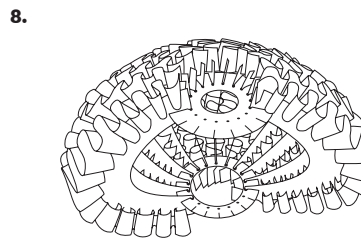

Half of the side elements secured to the top and bottom modules. Continue until all 18 side modules are secured.

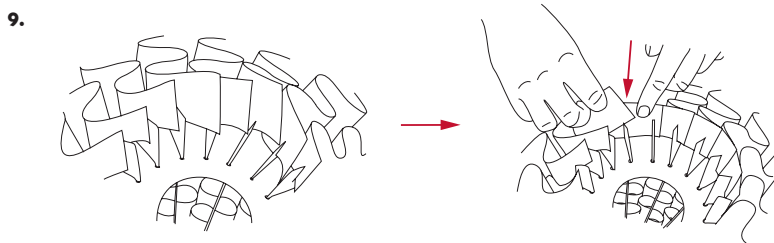

All strips are arranged nicely by tightening the top of the strip in the side element. This way you create an even edge on the top and bottom of the lampshade.

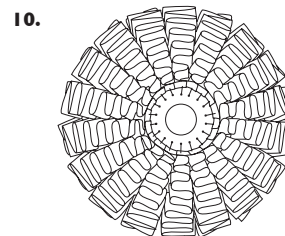

Assembled lampshade seen from above.

12 II.

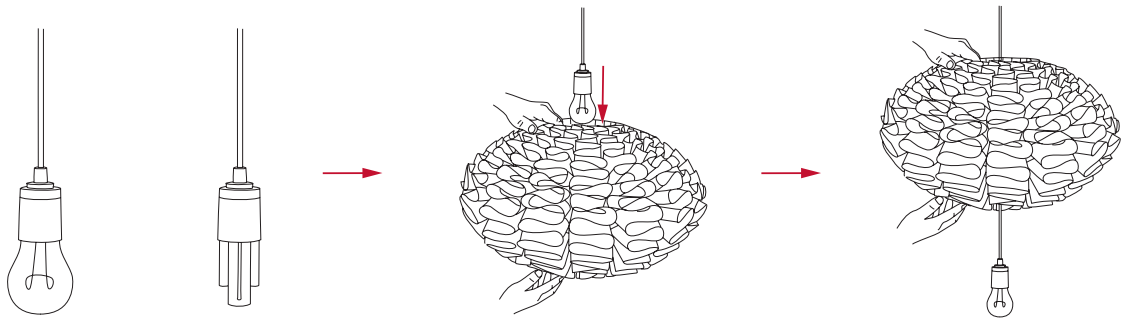

Lower the cord with complete fixing and light bulb through the lampshade. (Fixtures not included).

12.

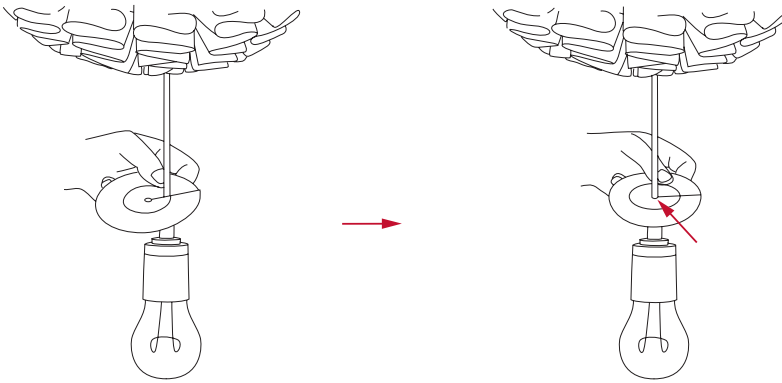

Fit the suspension piece around the cord.

13.

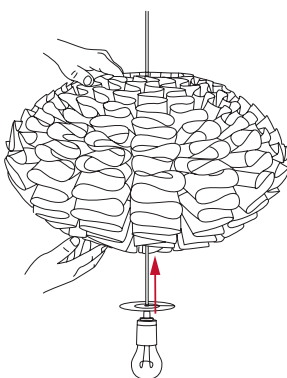

Now pull it all up through the lampshade until the suspension piece rests on the top module.

14.

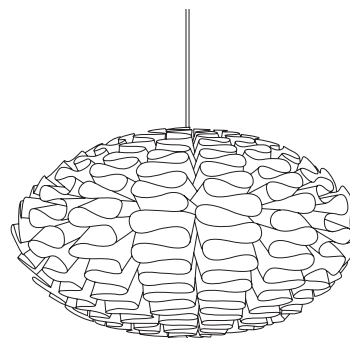

Completed lamp shade. Ready to hang.  
**MAX: 60 WATT** or low energy light bulbs.

# 13 Inhalt:

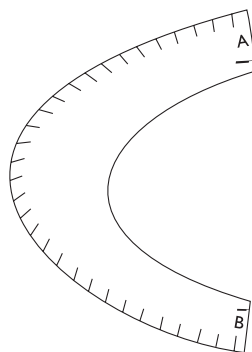

18 Seitenelemente

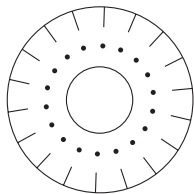

1 Topmodul

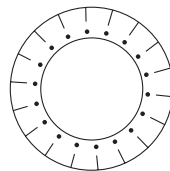

1 Bodenmodul

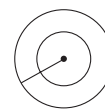

1 Halterung

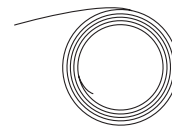

1 Rolle = 18 Streifen



Rolle mit 31 Markierungen

## Montage-Anleitung:

1.

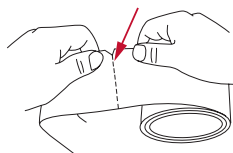

Nehmen Sie die Rolle mit den Streifen aus der Verpackung. Rollen Sie den ersten Streifen aus und trennen Sie ihn an der perforierten Linie.

2.

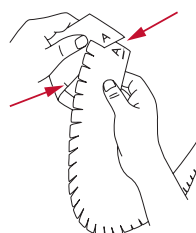

Stecken Sie den streifen in das Seitenelement. Beachten Sie bitte, dass sowohl Streifen als auch die Seitenelemente eine Topseite „T“ und eine Bodenseite „B“ haben. T = oben B = unten. Führen Sie den Streifen bei der ersten Markierung in den ersten Schlitz des Seitenelements.

3.

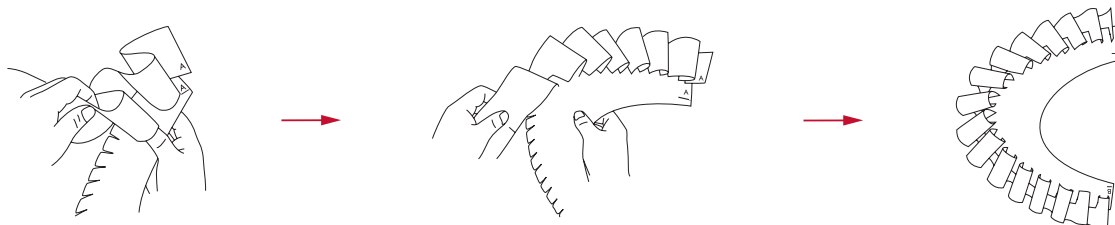

Führen Sie nächste Markierung in den nächsten Schlitz. Setzen Sie in gleicher Weise fort mit den nächsten - insgesamt 31 Schlitzten.

# 14

4.

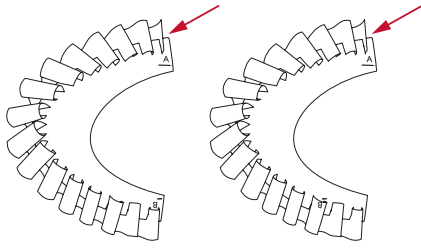

Wiederholen Sie diese Prozedur mit dem 2. Streifen und 2. Seitenelement. Beachten Sie bitte, dass Sie bei dem anstecken eines Seitenelementes immer von der gleichen Seite anfangen. Setzen Sie in gleicher Weise fort und setzen Sie die Streifen auf das Seitenelement – insgesamt 18 Stück.

5.

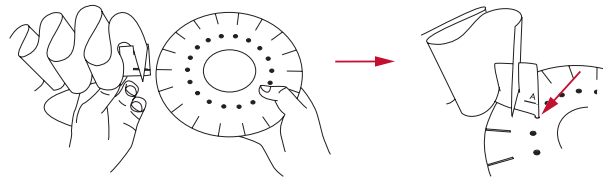

Nehmen Sie nun das Topmodul und stecken Sie das Seitenelement an. Schlitz gegen Schlitz. Das Seitenelement wird mit Hilfe der Lasche, die in das „Loch“ einrastet, befestigt.

6.

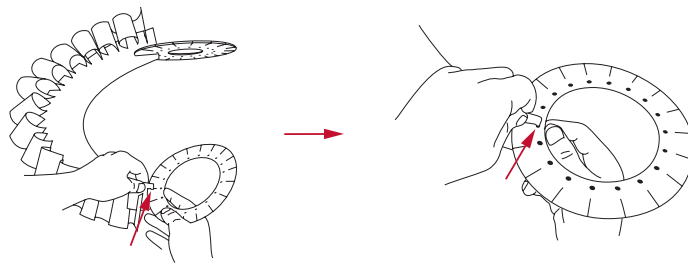

Nehmen Sie anschließend das Bodenmodul und stecken Sie das Seitenelement an. Schlitz gegen Schlitz. Das Seitenelement wird ebenfalls mit Hilfe der Lasche, die in das „Loch“ einrastet, befestigt.

7.

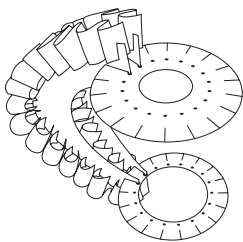

2 Seitenelemente werden an Top- und Bodenmodul befestigt.

8.

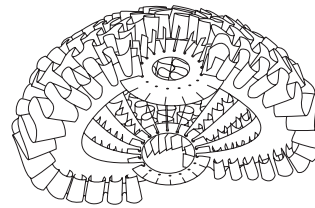

Die Hälfte der Seitenelemente werden an das Top- und Bodenmodul befestigt. Setzen Sie in gleicher Weise fort, bis alle Seitenelemente befestigt sind.

9.

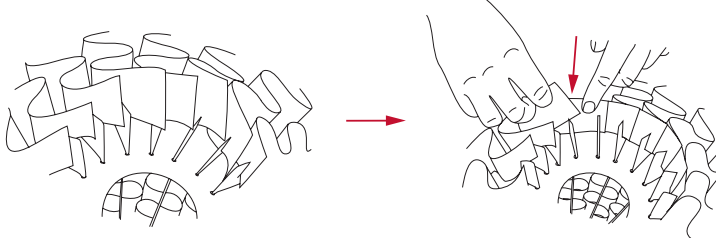

An der Spitze und am Boden der Lampe werden alle Streifen ausgerichtet, in dem man die Spitze des Streifen in das nächste Seitenelement steckt. Dadurch entsteht ein fester und stabiler Rand im oberen und unteren Teil der Lampe.

10.

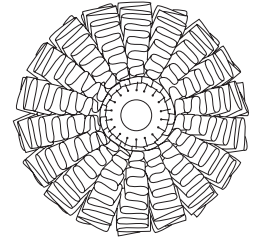

Draufsicht einer Fertigmontierten Lampe.

15 II.

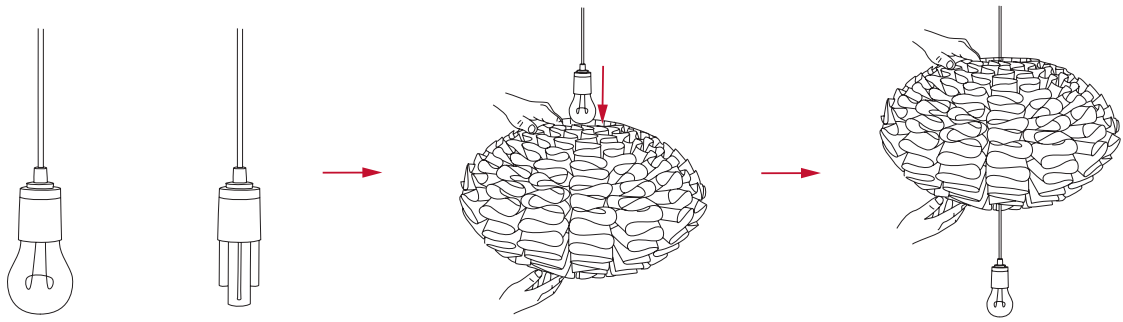

Führen Sie das Kabel mit Fassung und Glühlampe durch das obere Teil der Lampe. (Kabel, Fassung und Glühlampe muss separat gekauft werden)

12.

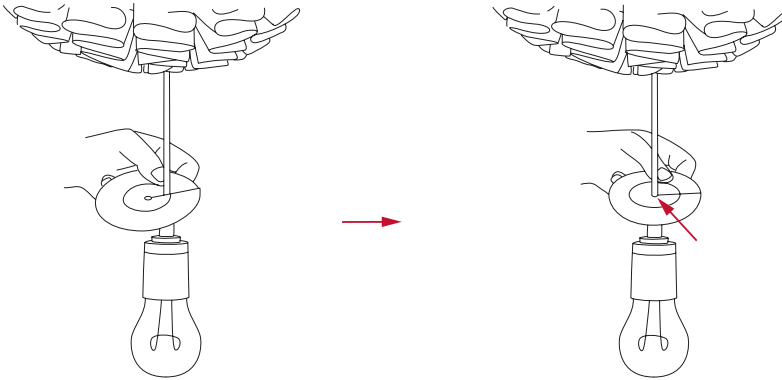

Wenn das Kabel mit Fassung durch die Lampe geführt worden ist, wird die Halterung an dem Kabel befestigt.

13.

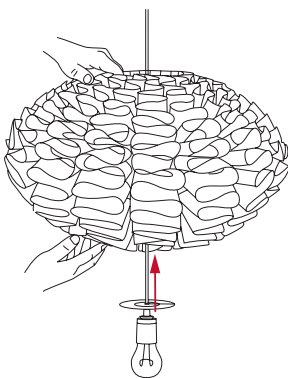

Ziehen Sie jetzt das Kabel mit Glühlampe durch die Lampe, bis die Halterung im oberen Teil ruht.

14.

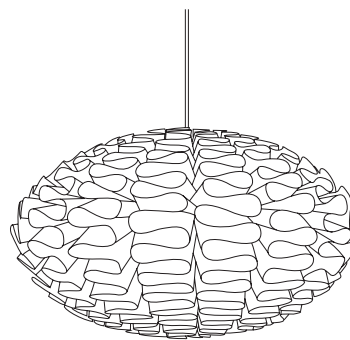

Die fertigmontierte Lampe, bereit zum aufhängen.  
Bitte nur Glühlampen bis **MAX 60 WATT** verwenden.



# 16 Sommaire:

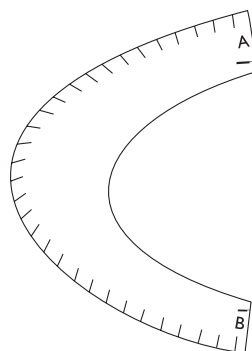

18 éléments latéraux

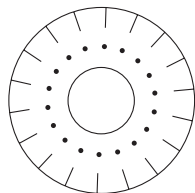

1 dessus

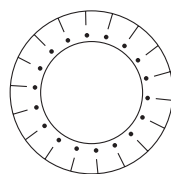

1 dessous

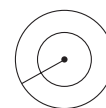

1 module de suspension

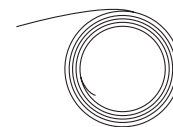

1 rouleau = 18 bandelettes



bandelette avec 31 marques

## Instructions d'assemblage:

1.

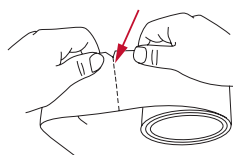

Ôter le rouleau de bandelettes de la boîte.  
Dérouler et détacher la première bandelette avec la ligne pointillée.

2.

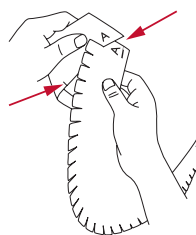

Poser la bandelette sur un élément latéral. Il est à noter que la bandelette et l'élément latéral ont tous deux une face supérieure et inférieure distinctes. A = face supérieure, B = face inférieure. Insérer la bandelette dans la première fente de l'élément latéral, à hauteur de la première marque.

3.



Insérer la marque suivante dans la fente suivante. Poursuivre de cette façon avec les fentes restantes (total : 31 fentes).

**normann**

C O P E N H A G E N

# 17

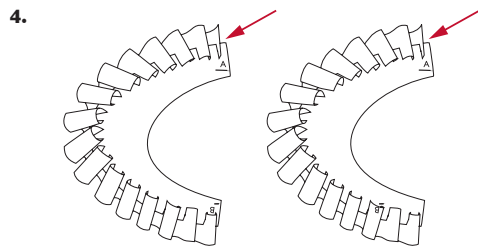

Répéter avec une deuxième bandelette et un deuxième élément latéral. Veiller toujours à entamer l'insertion de l'élément latéral du même côté. Poursuivre ainsi à insérer les bandelettes restantes dans les éléments latéraux (total : 18 ).

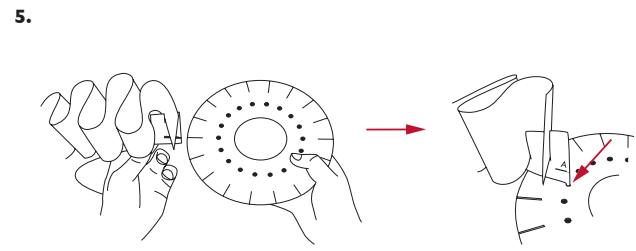

Prendre le dessus et insérer un élément latéral. Fente contre fente. Pour fixer l'élément latéral sur le dessus en emboîter la petite patte dans le trou.

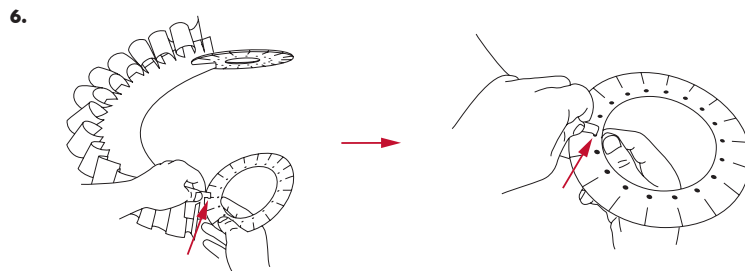

Prendre le dessous et insérer l'élément latéral. Fente contre fente. Pour fixer l'élément latéral sur le dessous, emboîter la petite patte dans le trou.

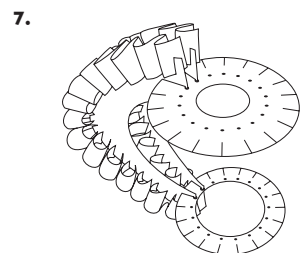

Deux éléments latéraux fixés sur le dessus et le dessous.

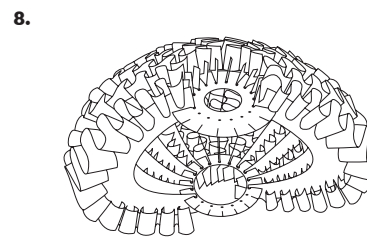

La moitié des éléments latéraux fixés sur le dessus et le dessous. Poursuivre jusqu'à ce que les 18 éléments latéraux soient fixés.

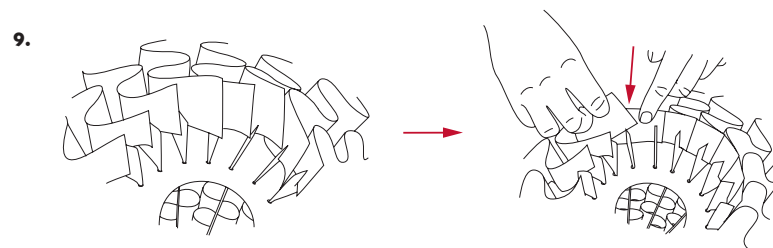

Sur le dessus et le dessous de la lampe, positionner correctement toutes les bandelettes en fixant le dessus de chacune d'entre elles dans l'élément latéral adjacent. Cette technique permet de former un bord stable et bien fini sur le dessus de la lampe.

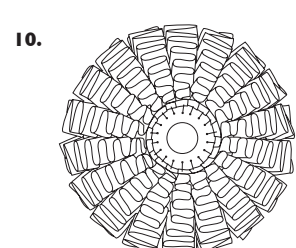

Lampe assemblée vue d'en haut.

18 II.

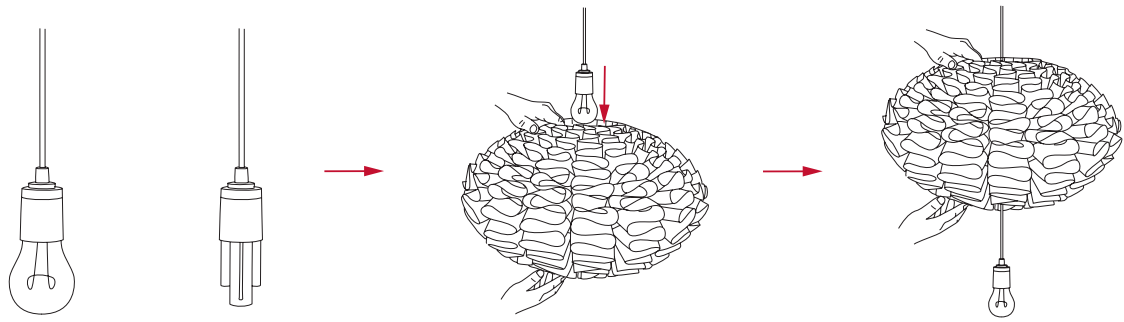

Par le dessus, insérer le câble avec la douille et l'ampoule à travers la lampe.

12.

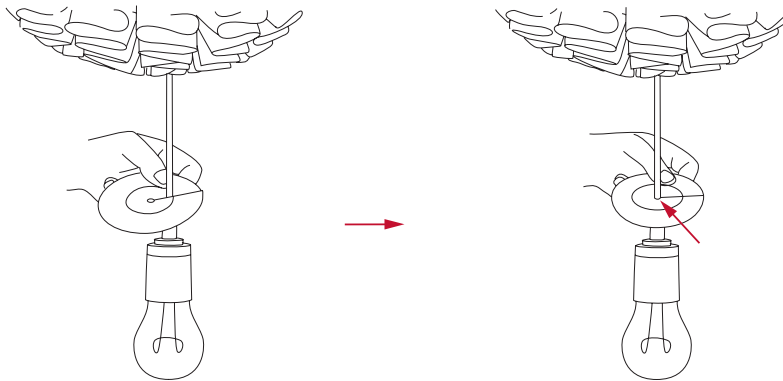

Après avoir fait descendre le câble avec la douille et l'ampoule dans la lampe, fixer le module de suspension au câble.

13.

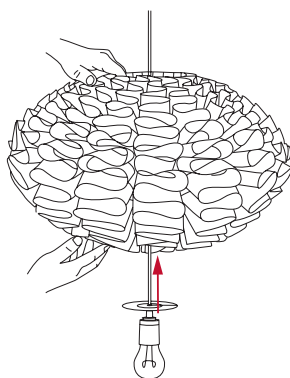

Tirer pour faire remonter le tout à travers la lampe, jusqu'à ce que le module de suspension repose sur le dessus.

14.

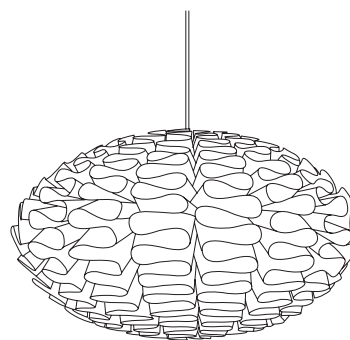

Lampe finie et prête à être suspendue.  
**Max. 60 watt.**

**normann**

C O P E N H A G E N

# 19 Contenido:

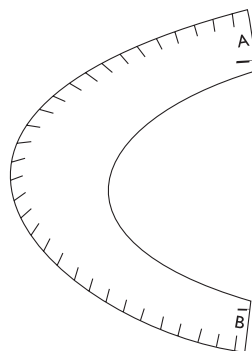

18 componentes laterales

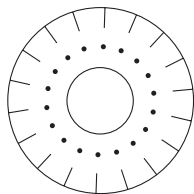

1 módulo superior

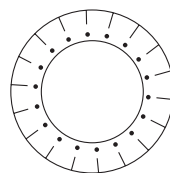

1 módulo inferior

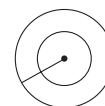

1 módulo de suspensión

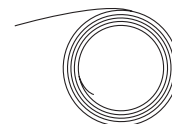

1 rollo = 18 tiras



Tira con 23 marcas

## Instrucciones de montaje:

1.

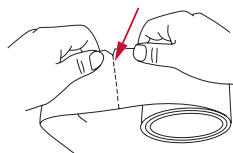

Saque de su embalaje el rollo con las tiras. Desenróllelo y corte la primera tira por la línea de puntos.

2.

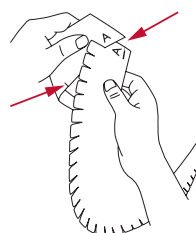

Coloque la tira en el componente lateral. Observe que tanto la tira como el componente tienen una parte inferior y una parte superior. A = parte superior B= parte inferior. Introduzca la primera marca de la tira en la primera ranura del componente lateral.

3.

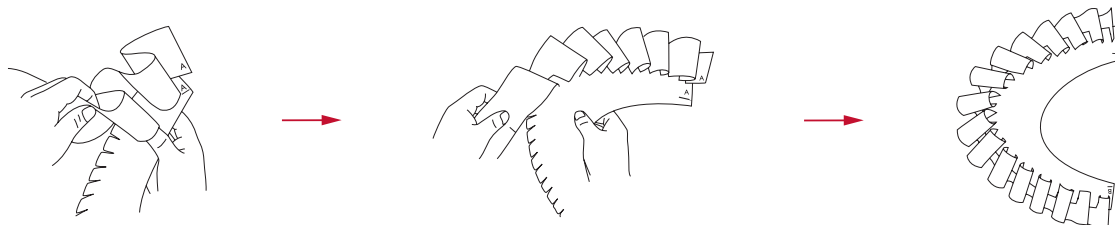

Introduzca la siguiente marca en la siguiente ranura, y así sucesivamente hasta las 31 ranuras.

20

4.

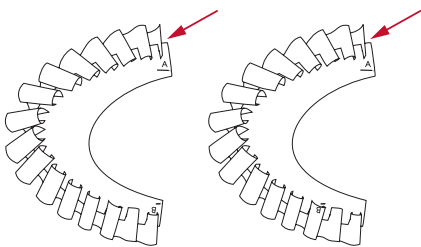

Repita el mismo procedimiento con la segunda tira y el segundo componente. Recuerde que ha de comenzar por el mismo lado del componente lateral. Continúe de la misma manera la introducción de tiras en los 18 componentes laterales.

5.

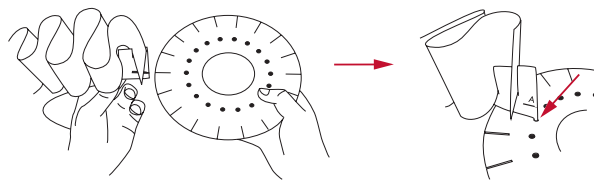

Introduzca el módulo superior en el componente lateral, ranura contra ranura. Fije el componente al módulo presionando la pequeña cuña dentro del agujero.

6.

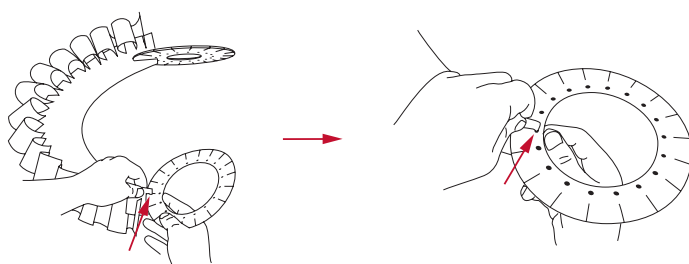

Introduzca el módulo inferior en el componente lateral, ranura contra ranura. Fije el componente al módulo presionando la pequeña cuña dentro del agujero.

7.

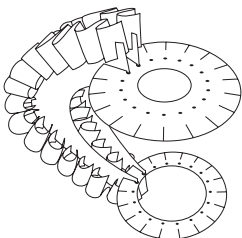

Dos componentes laterales fijados a los módulos superior e inferior.

8.

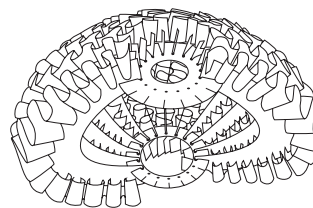

La mitad de los componentes laterales fijados a los módulos superior e inferior. Continúe hasta montar los 18 componentes laterales.

9.

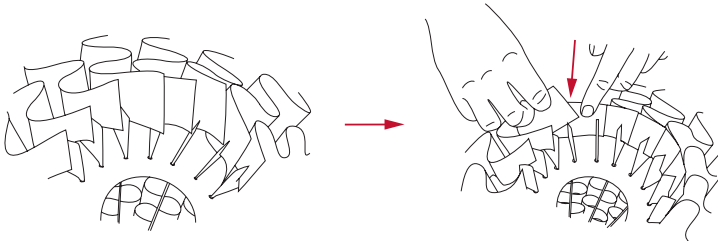

Coloque todas las tiras en la parte superior e inferior de la lámpara fijando la parte superior de la tira al componente lateral adyacente, consiguiéndose así un borde estable en la parte superior de la lámpara.

10.

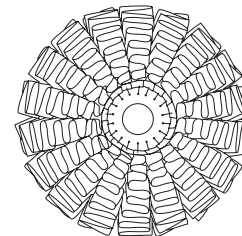

Lámpara ensamblada vista desde arriba.

21 II.

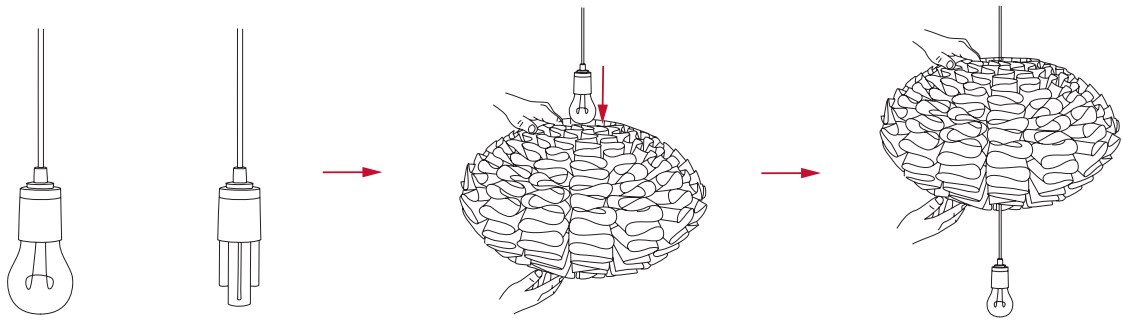

Haga pasar el cable con el portalámpara y la bombilla a través de la lámpara introduciéndolo desde la parte superior de la misma.

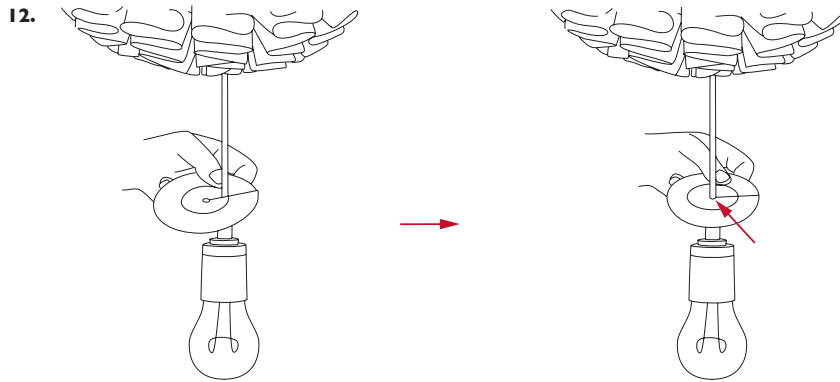

Una vez pasado el cable con el portalámpara y la bombilla a través de la lámpara, fije el módulo de suspensión al cable.

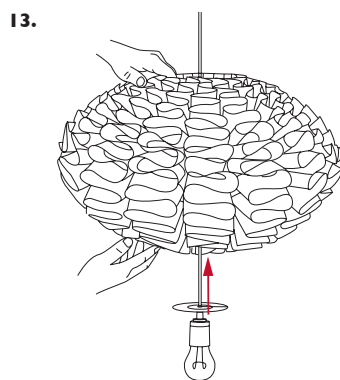

Vuelva a pasar el cable por la lámpara hasta que el módulo de suspensión repose sobre el módulo superior.

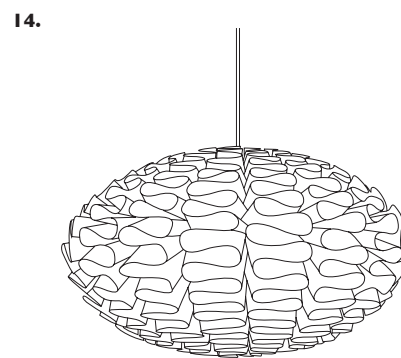

Lámpara terminada y lista para colgar. **Máx. 60 watt.**

## 22 Contenuto:

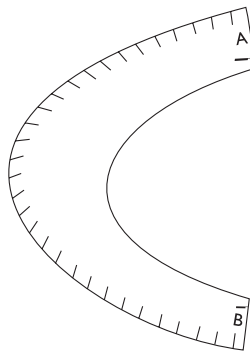

18 elementi laterali

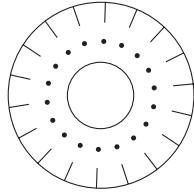

1 modulo superiore

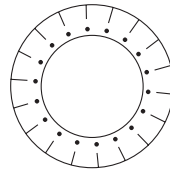

1 base

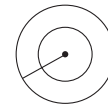

1 modulo di sospensione

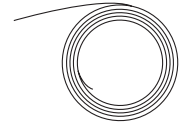

1 rotolo = 18 strisce



Striscia con 31 segni

### Istruzioni di montaggio:

1.

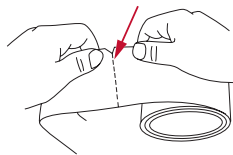

Estrarre il rotolo delle strisce dalla scatola. Srotolare e strappare la prima striscia in corrispondenza della zigrinatura.

2.

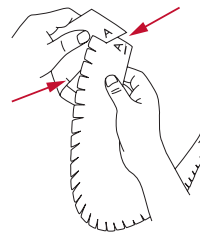

Applicare la striscia sull'elemento laterale. Osservare che sia la striscia sia l'elemento laterale hanno un'estremità superiore e una inferiore. A = estremità superiore, B = estremità inferiore. Inserire la striscia nella prima tacca dell'elemento laterale, in corrispondenza del primo segno.

3.

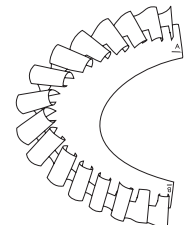
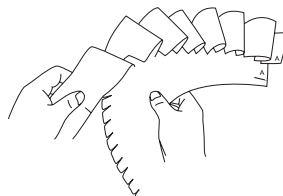
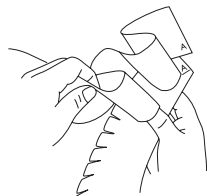

Inserire il segno successivo nella tacca successiva. Procedere allo stesso modo con tutte le 31 tacche.

**normann**

C O P E N H A G E N

# 23

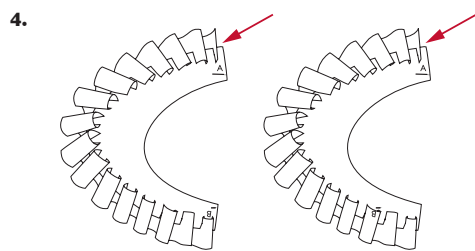

Ripetere l'operazione con la seconda striscia e il secondo elemento laterale. È importante iniziare sempre dalla stessa estremità. Procedere allo stesso modo applicando le strisce su tutti gli elementi laterali. Gli elementi laterali sono in tutto 18.

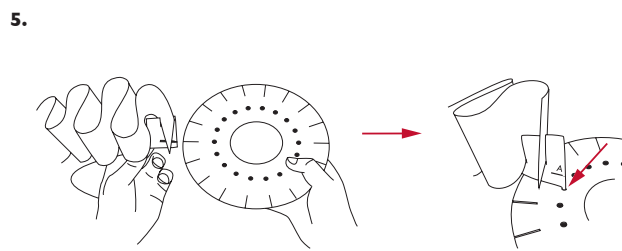

Applicare un elemento laterale al modulo superiore, tacca contro tacca. Bloccare l'elemento laterale in posizione inserendo la linguetta nell'apposito foro del modulo superiore.

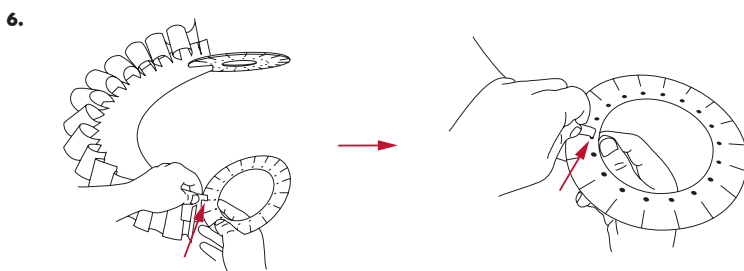

Applicare un elemento laterale alla base, tacca contro tacca. Bloccare l'elemento laterale in posizione inserendo la linguetta nell'apposito foro della base.

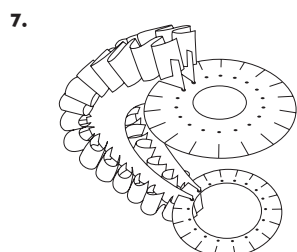

Due elementi laterali fissati al modulo superiore e alla base.

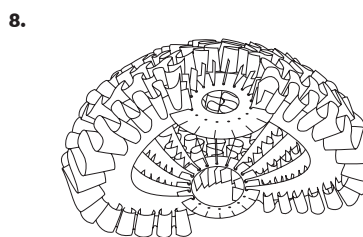

Metà degli elementi laterali fissati al modulo superiore e alla base. Proseguire fino all'applicazione di tutti i 18 elementi laterali.

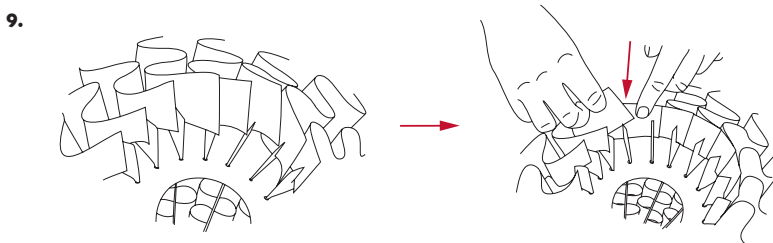

Sistemare tutte le strisce sulla sommità e sulla base del paralume fissando l'estremità di ogni striscia all'elemento laterale a fianco. In tal modo si crea un bordo preciso e stabile sulla sommità del paralume.

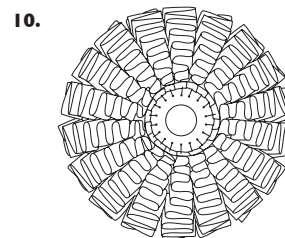

Il parasole assemblato visto dall'alto.



24  
11.

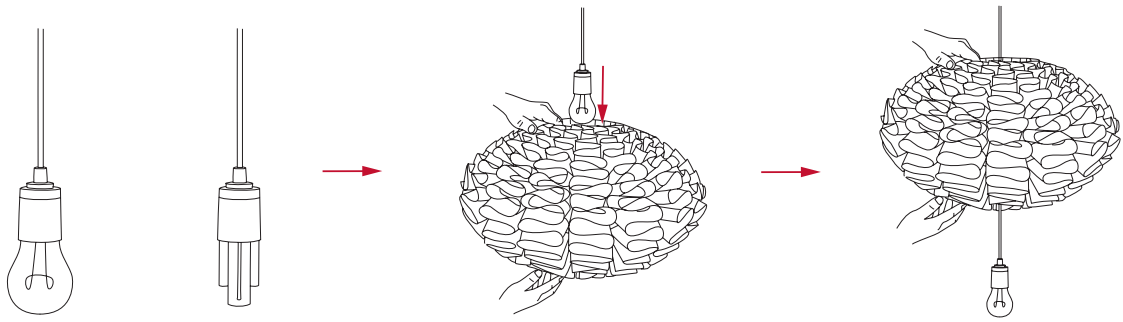

Introdurre il cavo con il portalamпада e la lampadina nel paralume, dalla sommità verso la base.

12.

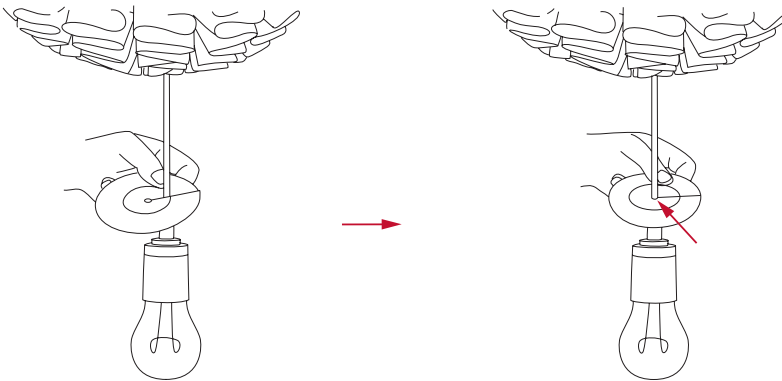

Dopo aver introdotto il cavo con il portalamпада e la lampadina attraverso il paralume, fissare il modulo di sospensione al cavo.

13.

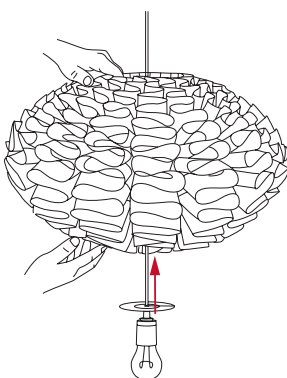

Tirare il cavo verso l'alto fino a bloccare il modulo di sospensione contro la sommità del paralume.

14.

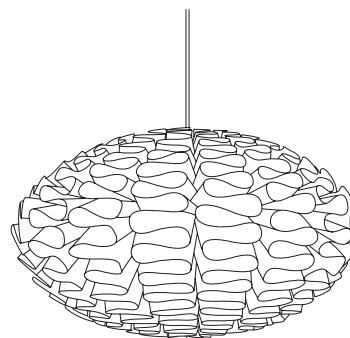

Paralume completo, pronto per l'uso. **Max 60 watt.**

**normann**

C O P E N H A G E N

## 25 Inhoud:

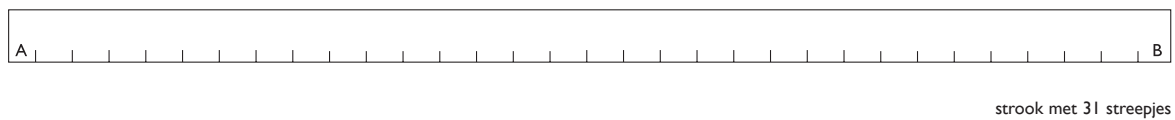
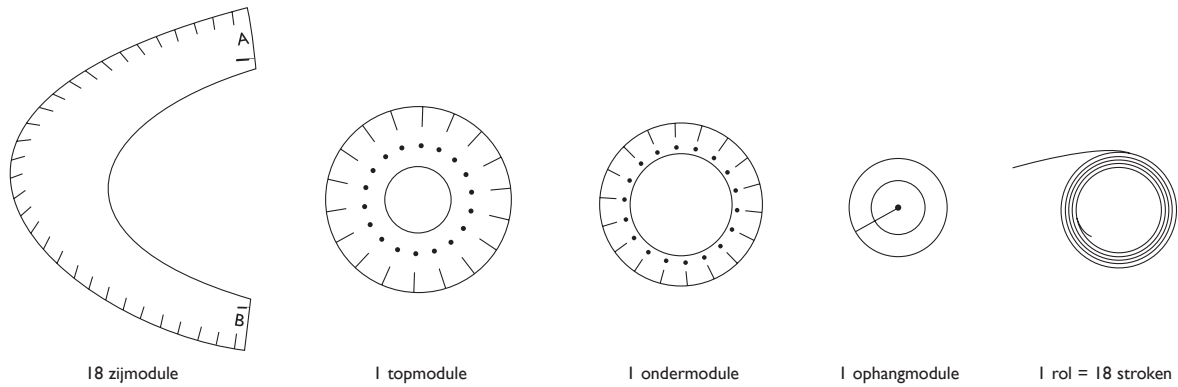

### Handleiding:

1.

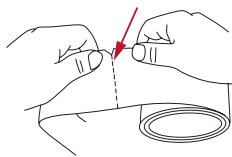

Neem de rol stroken uit de verpakking. Rol hem uit en scheur de eerste strook af bij de stippellijn.

2.

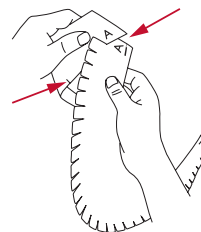

Zet de strook op een zijmodule. Let op: de strook en de zijmodule hebben een boven- en onderkant. A = boven, B = onder. Schuif de strook bij het eerste streepje in de eerste inkeping van de zijmodule.

3.

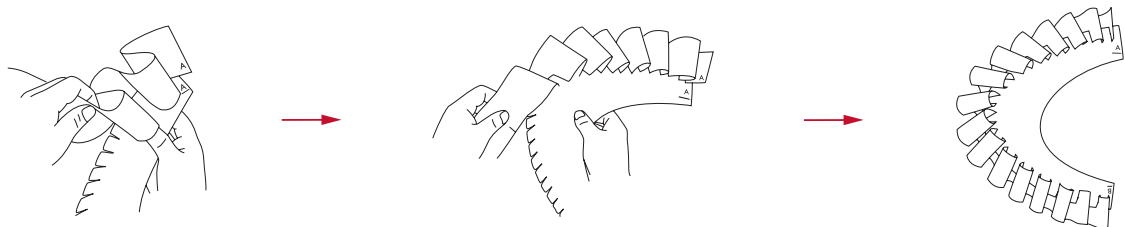

Schuif de strook bij het volgende streepje in de volgende inkeping. Vervolg deze handeling voor alle 31 streepjes.

**normann**

C O P E N H A G E N

# 26

4.

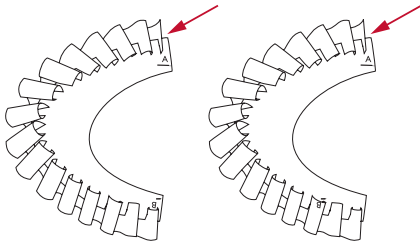

Herhaal dit met de tweede strook en de tweede zijmodule. Zorg ervoor dat het begin van de strook dezelfde kant op wijst als bij de eerste strook. Zet op deze manier alle stroken en zijmodules in elkaar (18 in totaal).

5.

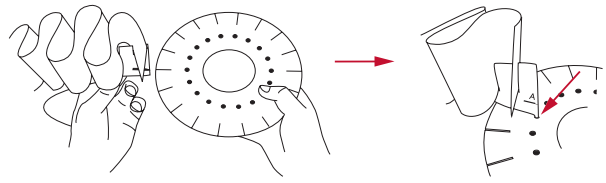

Schuif een zijmodule in de topmodule met de inkepingen in elkaar. De zijmodule wordt gezekerd door het uitsteekseltje in het gaatje te klikken.

6.

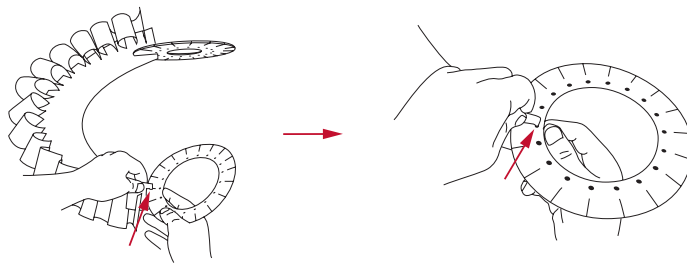

Schuif een zijmodule in de ondermodule met de inkepingen in elkaar. De zijmodule wordt gezekerd door het uitsteekseltje in het gaatje te klikken.

7.

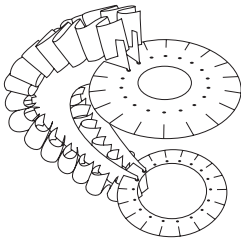

Twee zijmodules, bevestigd aan de topmodule en ondermodule.

8.

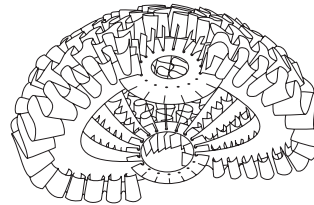

De helft van de zijmodules, bevestigd aan de topmodule en ondermodule. Ga ermee door tot alle zijmodules bevestigd zijn.

9.

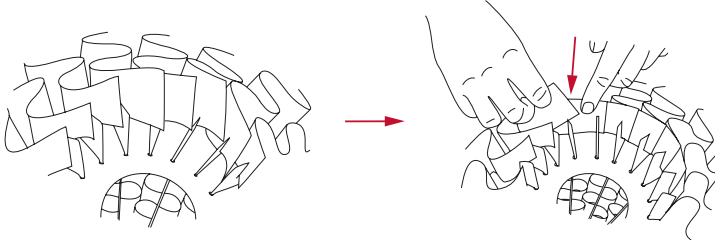

Aan de boven- en onderkant van de lamp komen alle zijmodules netjes naast elkaar door het uiteinde van een strook aan de zijmodule ernaast vast te maken. Zo ontstaat er een mooie, stevige rand.

10.

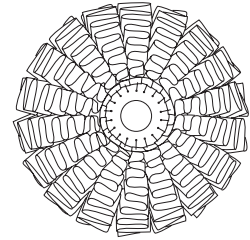

In elkaar gezette lampenkap van boven gezien.

27 11.

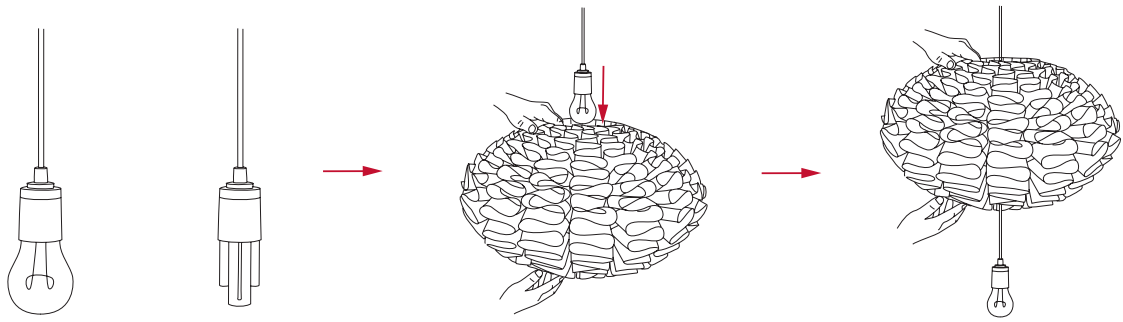

Laat het snoer met fitting en lamp van bovenaf door de lampenkap heen zakken.

12.

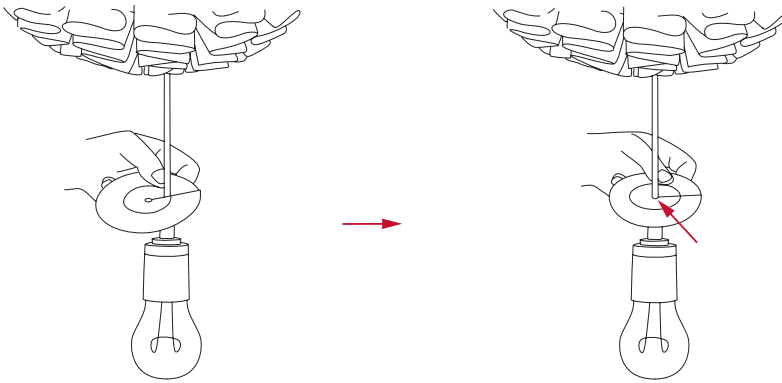

Als het snoer met fitting en lamp door de lampenkap heen is, komt de ophangmodule aan het snoer.

13.

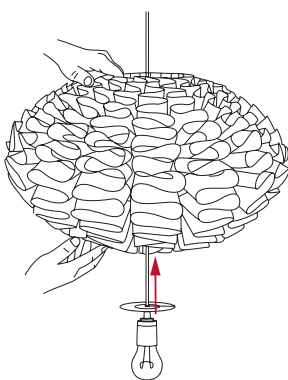

Trek nu het snoer naar boven, tot de ophangmodule op de topmodule rust.

14.

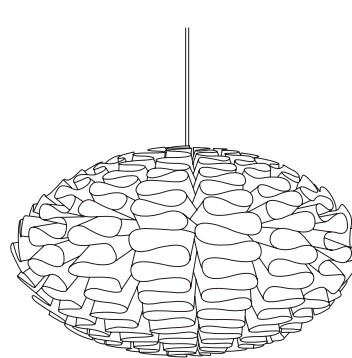

De voltooide lamp, klaar om op te hangen. **Max. 60 watt.**

**28** 中味

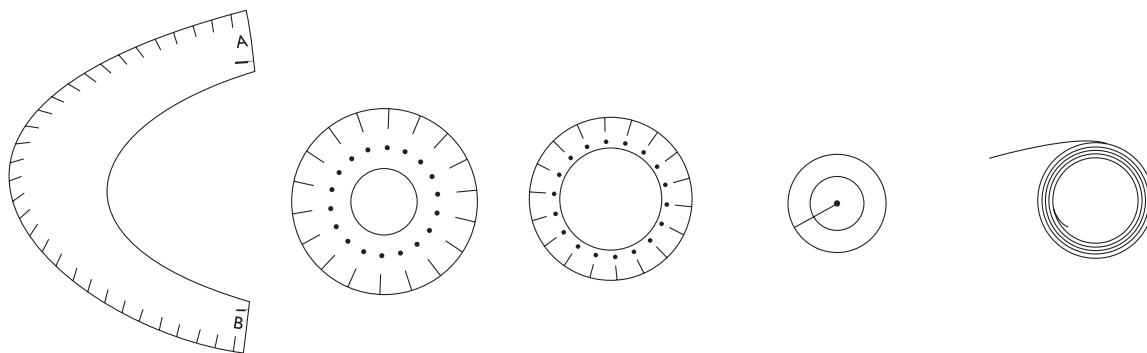

サイドエレメント 18個      トップモジュール 1個      底モジュール 1個      吊り下げ用モジュール1個      ロール1個=細ひも18本



31個マーク付き細ひも

組み立て方

1.

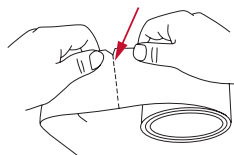

細ひもの付いているロールをケースから出してください。  
伸ばして点線のところにある最初の細ひもを切り裂いてください。

2.

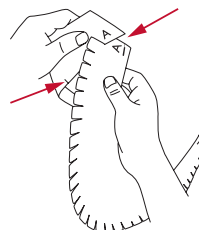

細ひもをサイドエレメントにつけてください。  
細ひももサイドエレメントもトップと底同士が合うように気をつけてください。  
A=トップB=底。細ひもは最初のマークがついているところでサイドエレメントの最初の切れ目に入れてください。

3.

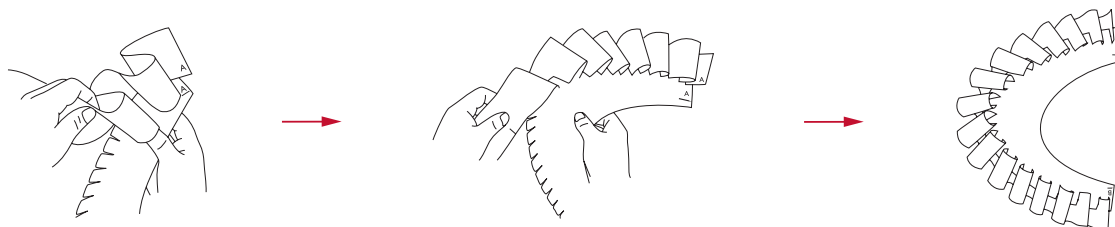

次のマークは次の切れ目に入れてください。同様に31個の切れ目に入れてください。

29

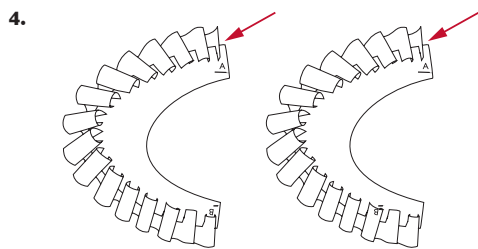

2本の細ひもと2個のサイドエレメントで繰り返してください。  
サイドエレメントを入れる時は同じ側からするように留意してください。  
同様に細ひもをサイドエレメントに入れ続けてください。全部で18個。

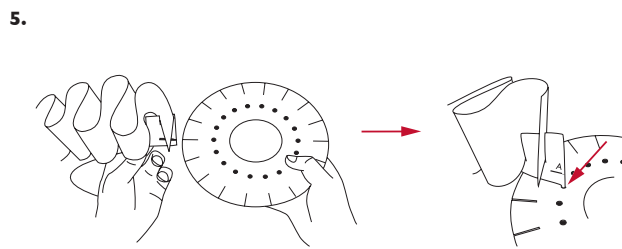

トップモジュールをとり、サイドエレメントに挿入してください。  
切れ目と切れ目同士を合わせるようにしてください。  
サイドエレメントは、小さなスリッの穴にカチッとはめ込み、  
トップモジュール上に固定してください。

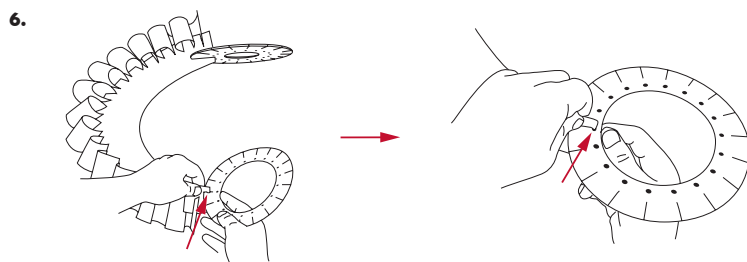

底モジュールをとり、切れ目と切れ目同士を合わせてサイドエレメントに挿入してください。  
サイドエレメントは、小さなスリッの穴にカチッとのはめ込み、トップモジュール上に固定してください。

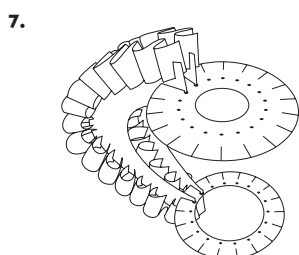

サイドエレメント2個をトップモジュール上に固定してください。

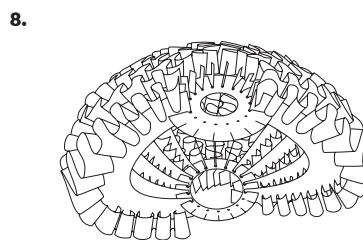

サイドエレメントの半分をトップと底モジュール上に固定してください。  
18個のサイドエレメントが全てはめ込まれるまで続けてください。

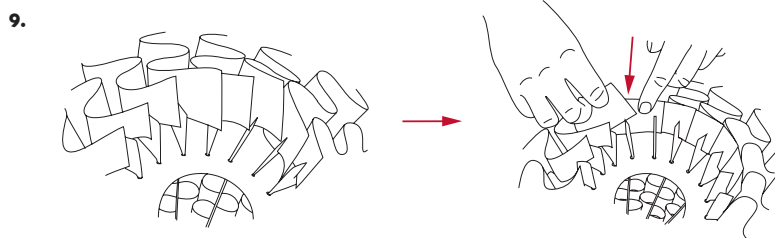

細ひものトップがサイドエレメントに固定されるようにしてラ  
ンプのトップと底に細ひもを挿入してください。  
最後にはランプのトップにきれいな安定した線ができます。

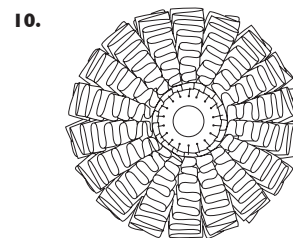

上から見た組み立て済みのランプ。

30  
11.

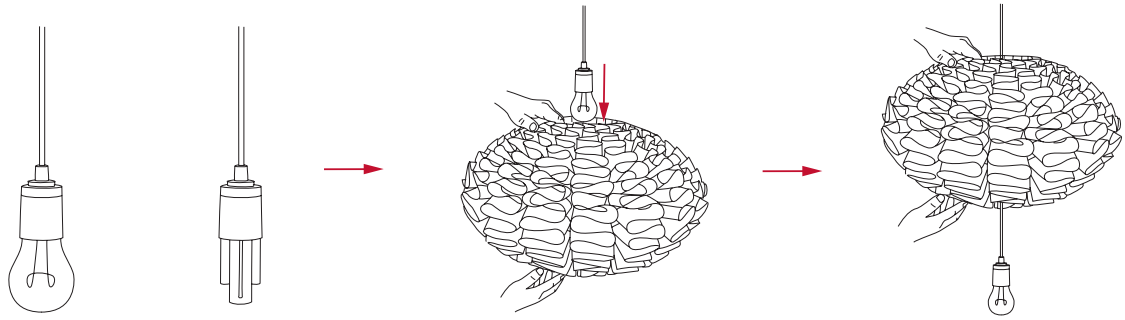

ソケット付きコードと電球をトップから下までランプの中に通してください。

12.

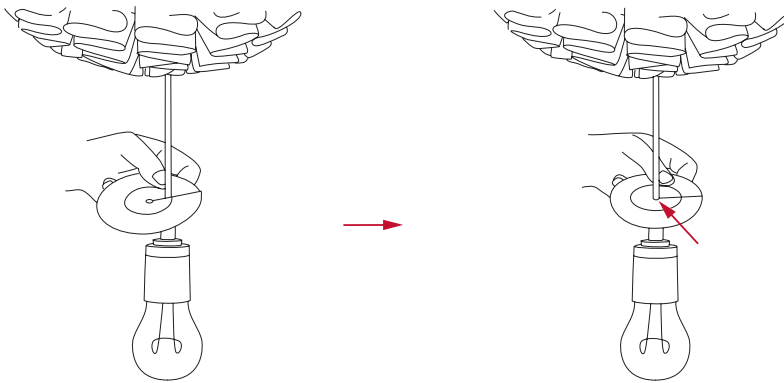

ソケット付きコードと電球がランプの中に通されたら、吊り下げ用モジュールをコードに固定してください。

13.

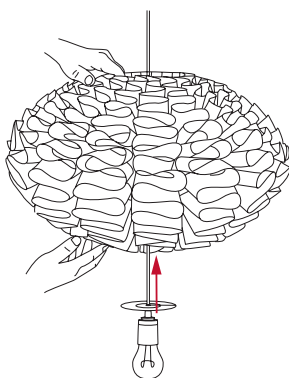

今度は全てをランプの中に入れてひっぱり、吊り下げ用モジュールがトップモジュール上にあるようにしてください。

14.

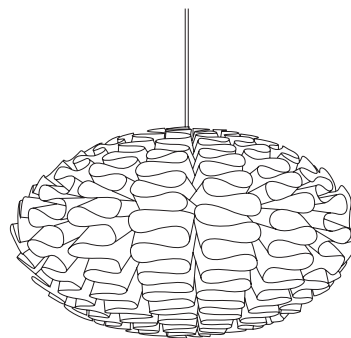

組み立て済みランプ。吊り下げ準備完了。最大60ワット。

# 31 组件:

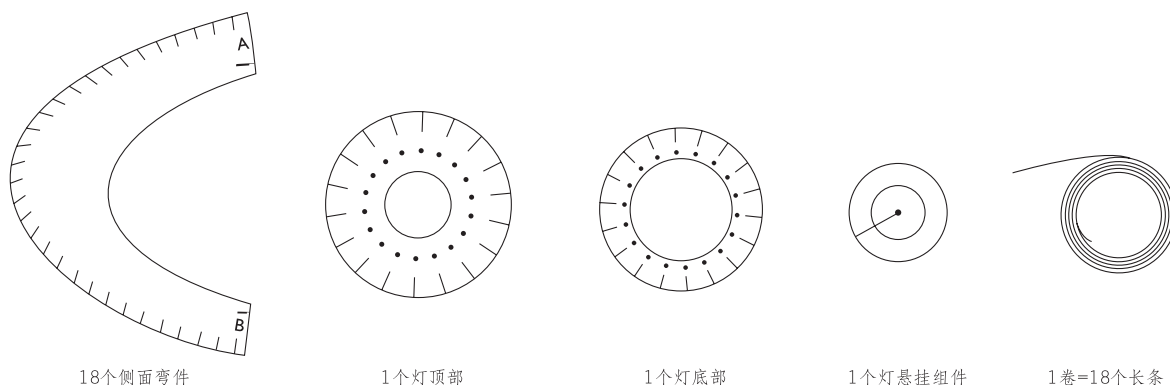

带有31个标记的长条

## 安装指南:

1.

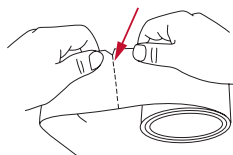

从箱子里取出长条卷。把它解开来并沿着虚线把第1个长条撕下来。

2.

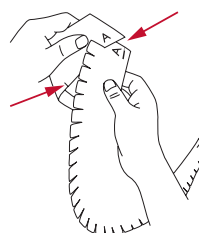

把长条装在侧面弯件。请注意长条和侧面弯件都有顶部和底部区别。A等于顶部，B等于底部。长条上的第一个标记要装在侧面弯件的第一个切缝上。

3.

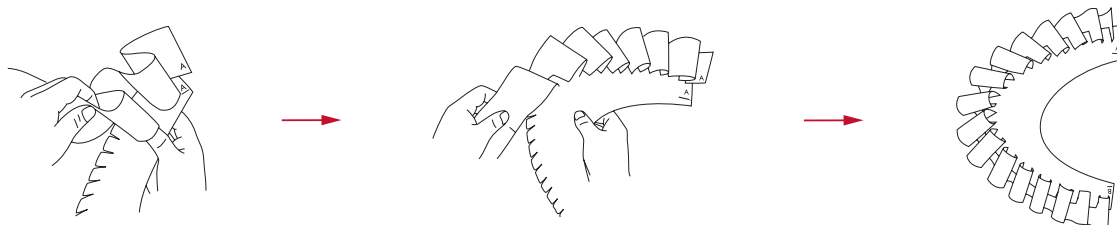

接着把第二个标记再装到第二个切缝上，然后继续用同样的方法装上其余的部分直至31个标记和31个切缝都对准装上。



# 32

4.

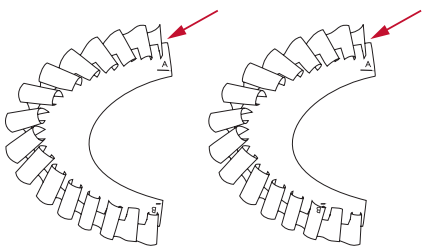

用同样的方法把第2个长条装在第二个侧面弯件上。要记住在装长条和侧面弯件时起头都要一样。继续用同样的方法把其它的长条装在侧面弯件上。共有18个这样的侧面组件。

5.

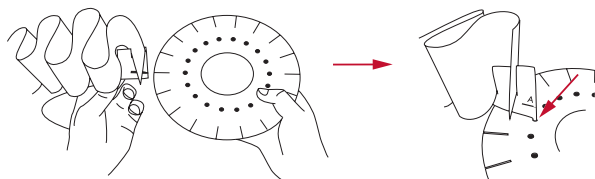

取灯的顶部，然后把侧面组件装上去。要切缝对着切缝。用一个卡入小孔里的小片条把侧面组件锁在灯顶部的位罝。

6.

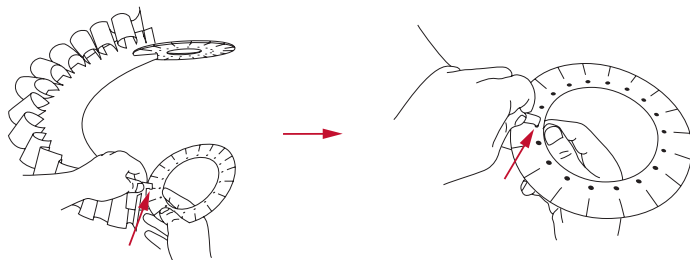

取灯的底部，把侧面组件装上去。切缝对着切缝。用一个卡入小孔里的小片条把侧面组件锁在灯底部的位罝。

7.

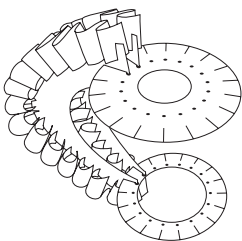

此图为两个侧面组件被连接在灯顶部和底部的位罝。

8.

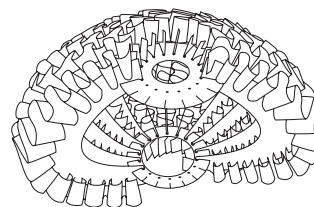

此图为有50%的侧面组件被连接在灯顶部和底部的位罝。继续使用同样的方法直至所有的18个侧面组件都被装上去。

9.

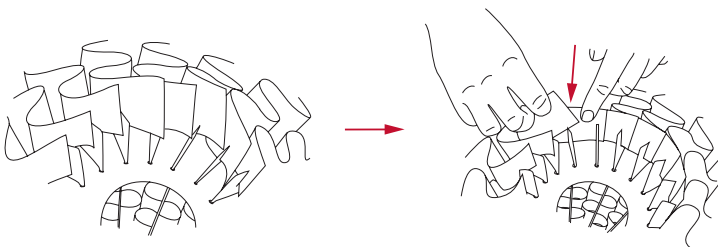

要把灯的顶部和底部的所有长条整理到适当的位置上，把长条的头端附于旁边的侧面组件上。当整理完毕之后，灯的顶部就形成美观又牢固的棱边。

10.

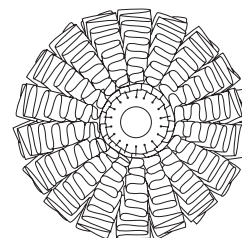

灯的俯视图。

**33**  
11.

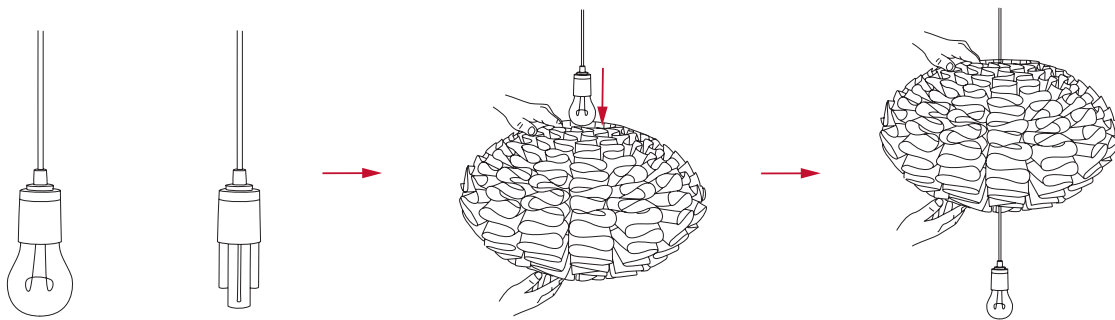

带有灯口和灯泡的电线要从灯的顶部中央往下垂放。

**12.**

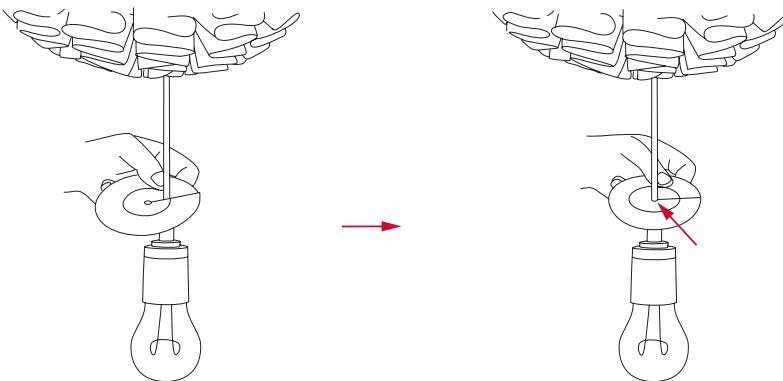

当带有灯口和灯泡的电线穿过灯并显露在另一头之后，就可以把灯悬挂组件装到电线上。

**13.**

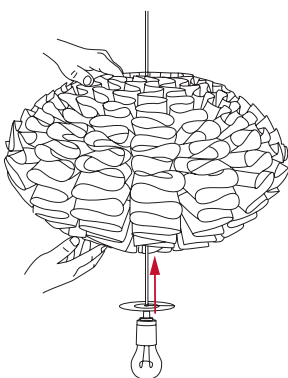

现在要把电线往上拉回直到悬挂组件可以搁置于灯的顶部。

**14.**

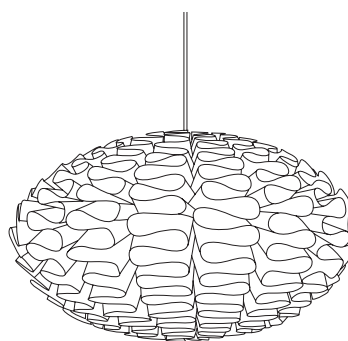

灯已做好，可以吊起来。**最大瓦数60瓦特。**