

# ASCENT

design Daniel Rybakken

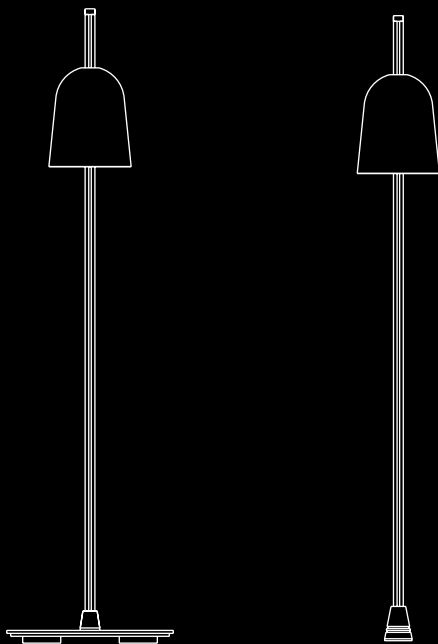

**LUCE  
PLAN**

D78





# ASCENT

design Daniel Rybakken



01



02

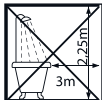

03



13



18

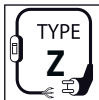

29



30



38



D78

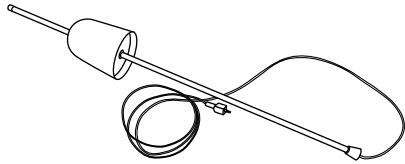
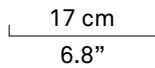
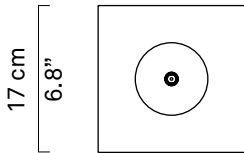
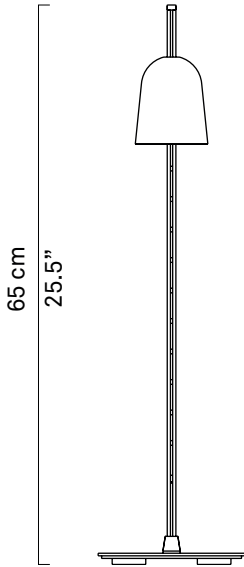

x 1

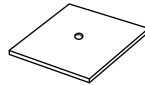

x 1



x 1

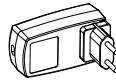

x 1

**kg** 1,7 kg

**lb** 3.8 lb

# ASCENT

design Daniel Rybakken

## D78 p.t.

 a

 b

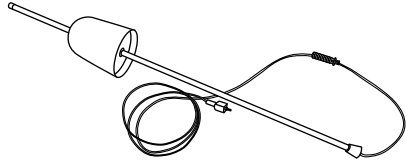
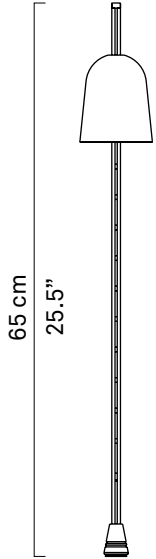

x 1



x 1



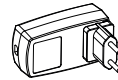

ø 8,5 cm

ø 3.3"



x 1

 0,6 kg

 1.4 lb

# 1 D78

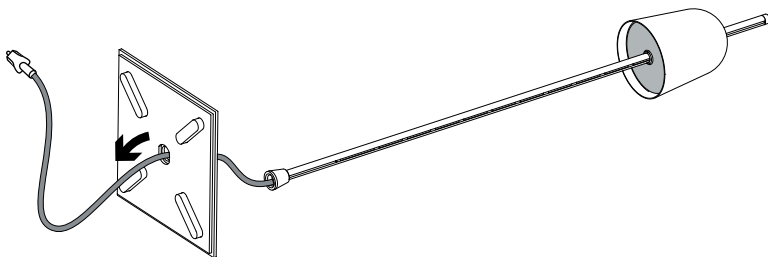

## 1.1

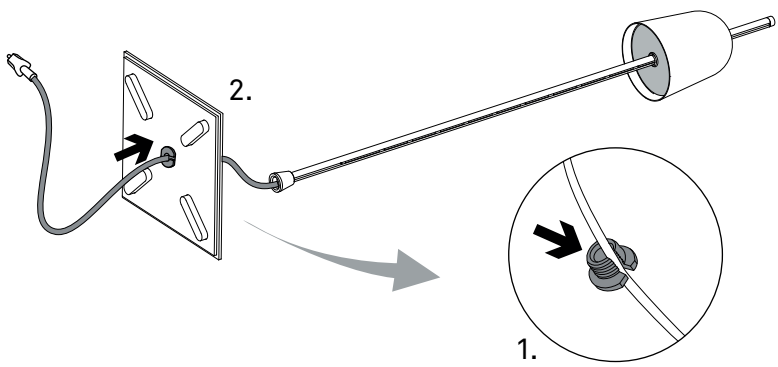



# 1.2

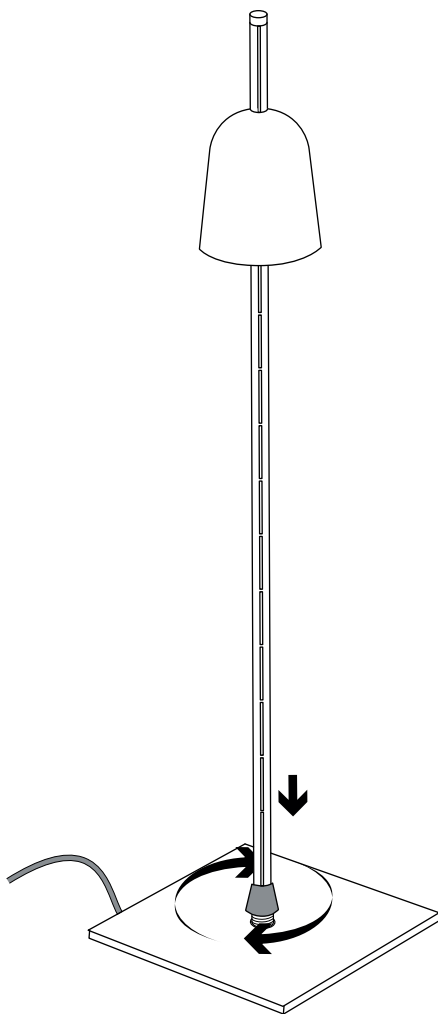

# 1 D78 p.t.

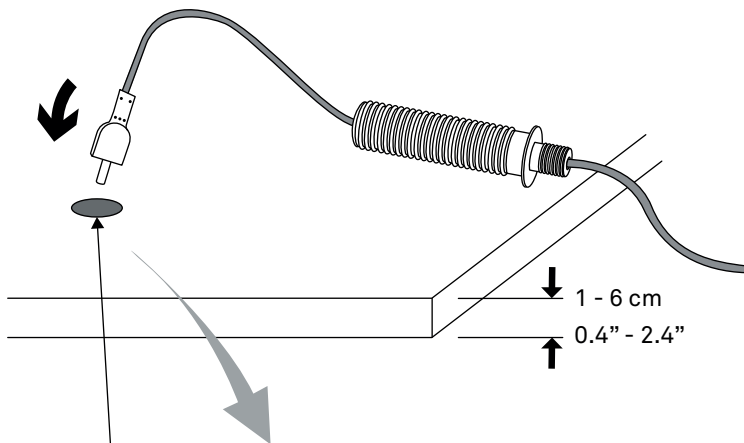

$\varnothing 2 \text{ cm}$   
 $\varnothing 0.8''$

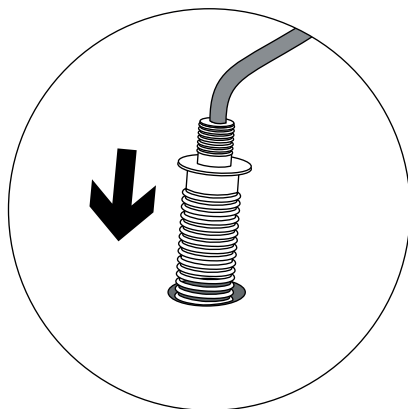

# 1.1

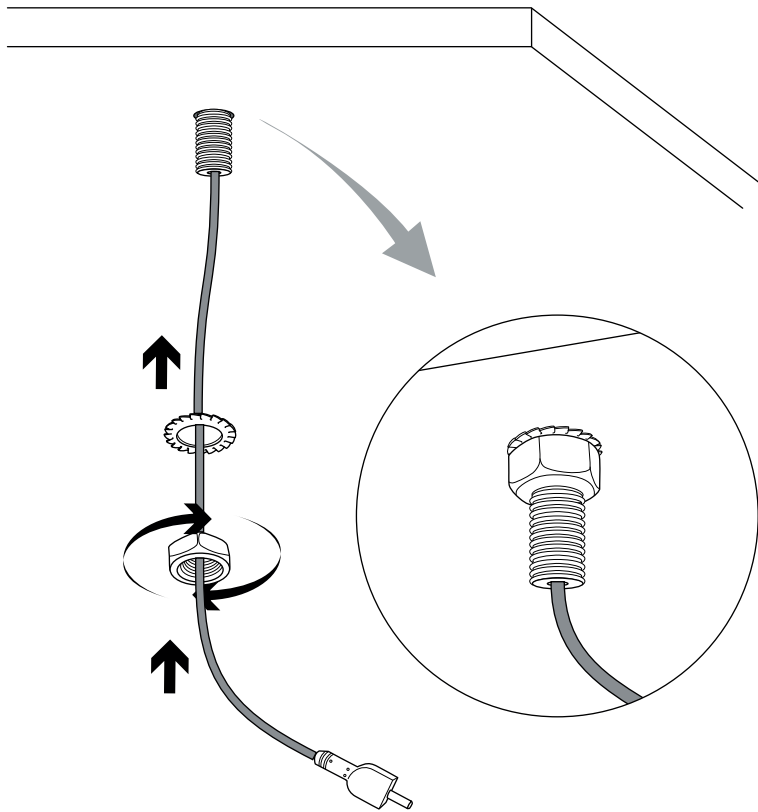



1.2

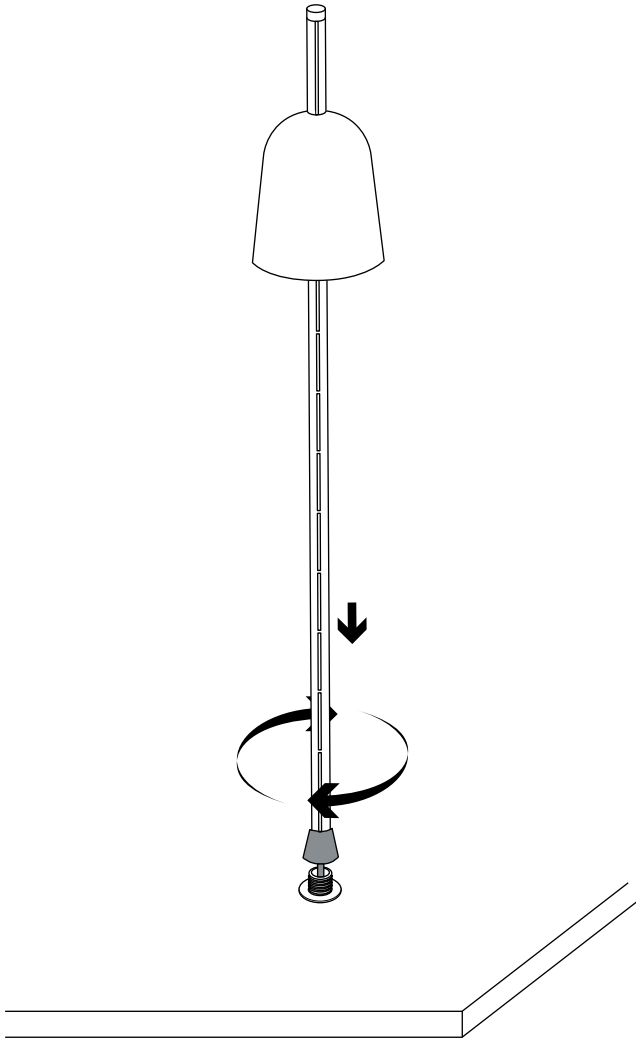

# 2



**OFF (RESET)**



**ON**



**OFF (RESET)**

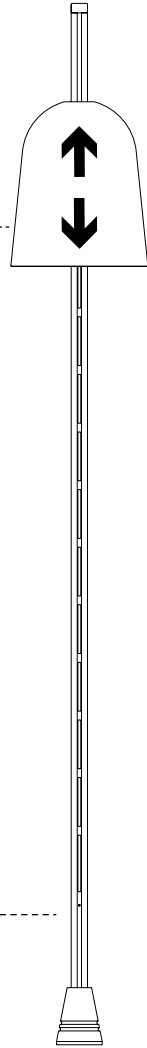

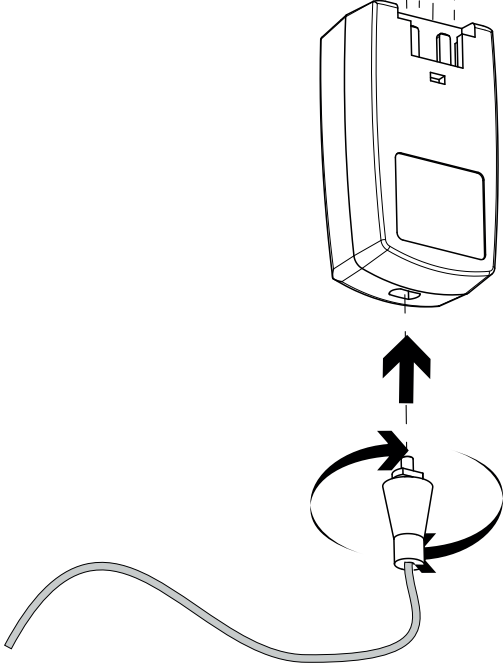
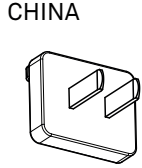
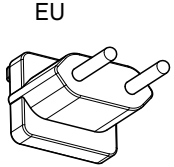
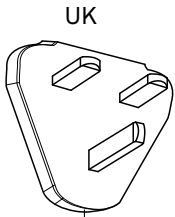
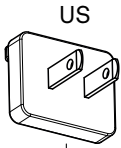

**LUCE  
PLAN**

[www.luceplan.com](http://www.luceplan.com)

D780IB201