

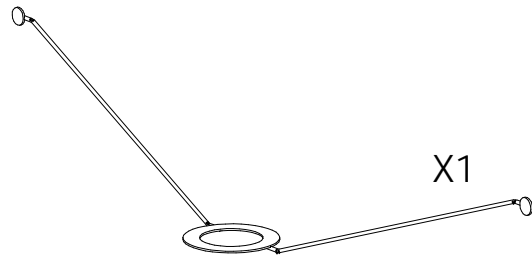

X1

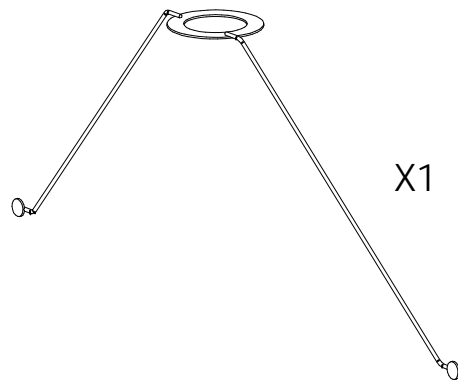

X1



X1

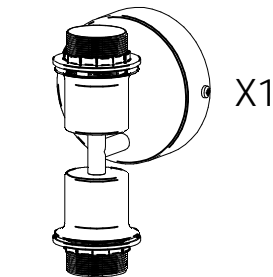

X1

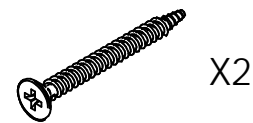

X2

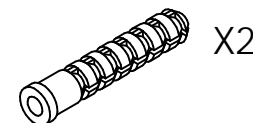

X2

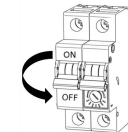

Ampoule non incluse
Bulb not included

Vous aurez besoin de:
You will need:

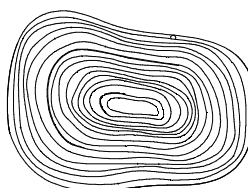
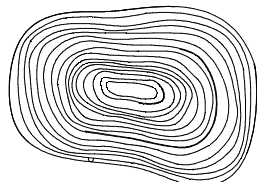
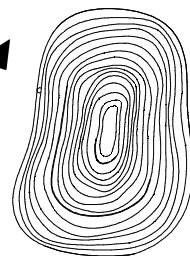
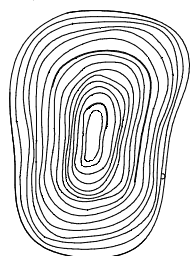
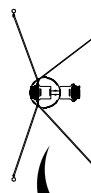
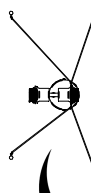
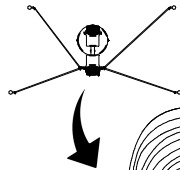
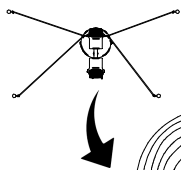
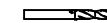
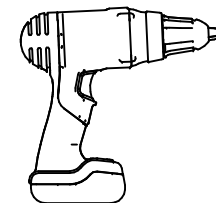

Sur votre produit, le symbole de la poubelle barrée d'une croix, indique qu'il est soumis à la directive européenne 2012/19/UE: les produits électriques, électroniques, les batteries et accumulateurs doivent impérativement faire l'objet d'un tri sélectif. Veuillez à déposer votre produit hors d'usage dans une poubelle appropriée, ou le restituer dans un point de collecte. Les collectivités ou les revendeurs vous communiquerons toutes les informations essentielles concernant l'élimination de votre ancien produit. Ne pas mettre votre ancien produit au rebut avec vos déchets ménagers permet de protéger l'environnement et la santé.



Pour utilisation à l'intérieur uniquement
For indoor use only



EF13190 M

rue Radio-Londres
33130 Begles

forestier
PARIS

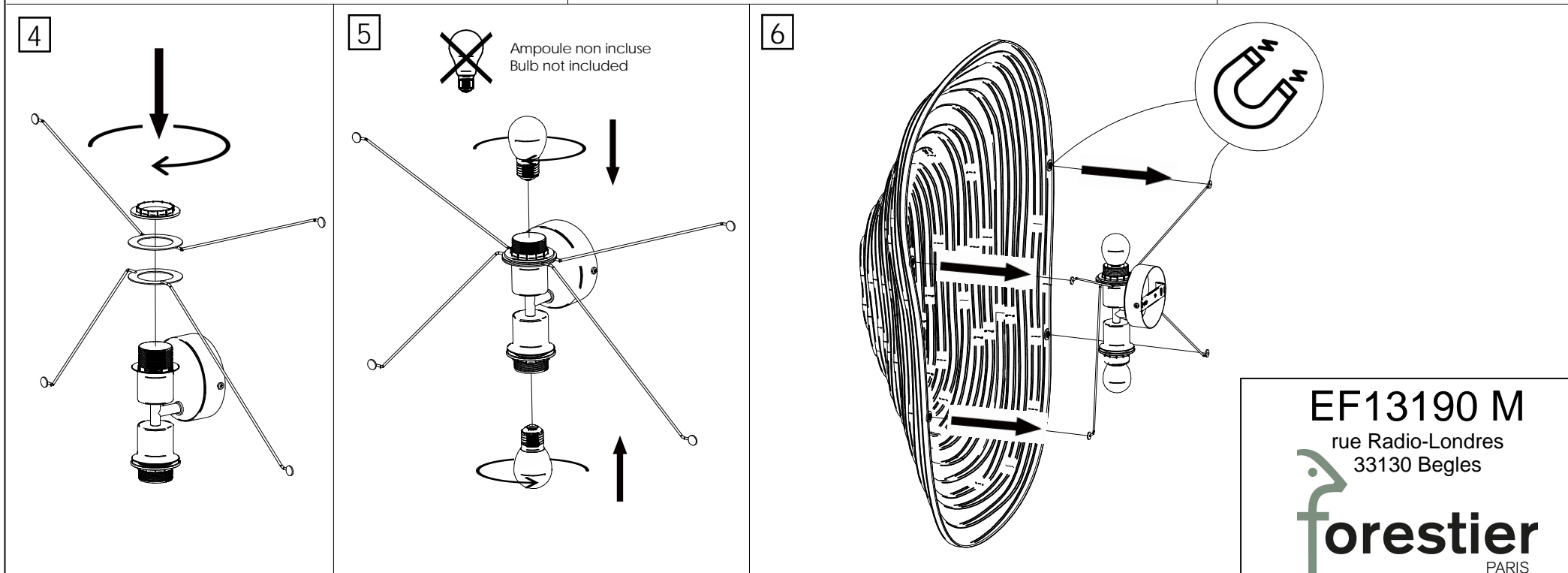
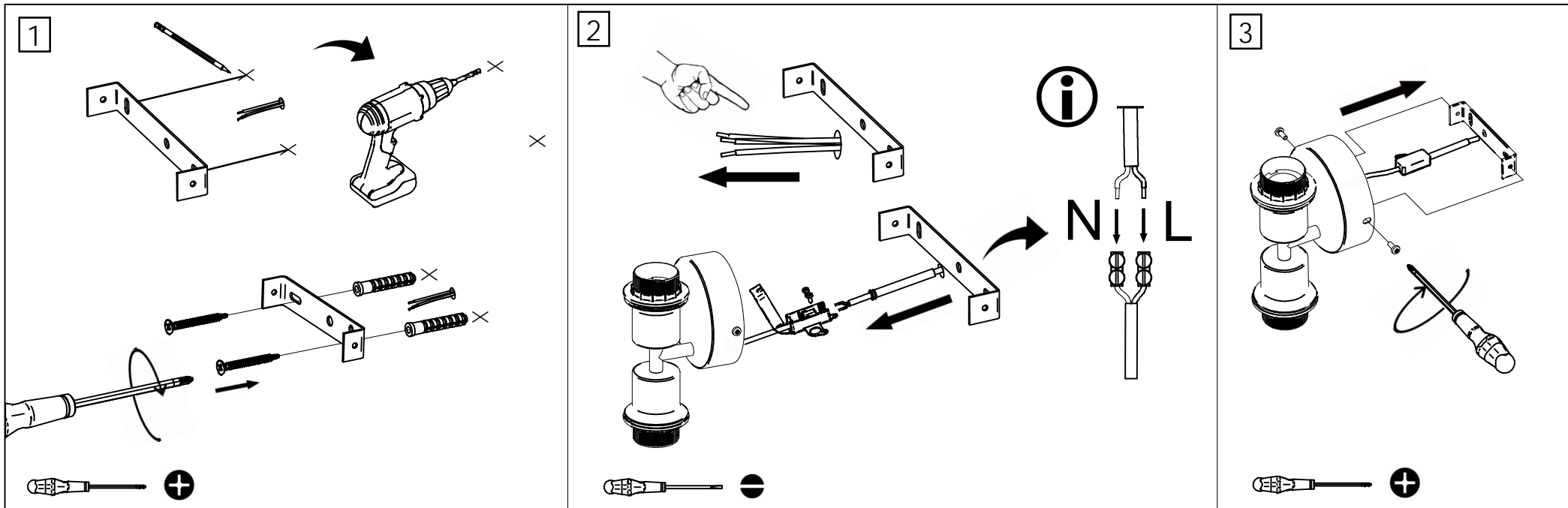

EF13190 M
 rue Radio-Londres
 33130 Begles

forestier
 PARIS