

NEON TUBE LED
INSTRUCTION MANUAL

Havnen 1 8700 Horsens Denmark
+45 4282 0282 / hay@hay.com

HAY

HAY

PARTS

TECHNICAL DATA

This product is supplied with an integrated LED module, the expected lifespan of the LED modules is 35,000 hours.

The light source of this luminaire is not replaceable; when the light source reaches its end of life the whole luminaire shall be replaced.

ATTENTION

The product must not be modified in any way. HAY accepts no responsibility for any products that have been modified or tampered with. The external flexible cable or cord of this luminaire cannot be replaced; if the cord is damaged, the luminaire should be destroyed. This lamp is designed for indoor use only.

Please note that the tube may curve slightly when in use. Tube will straighten when turned off.

CARE AND MAINTENANCE

The product can be cleaned with a soft damp cloth and mild detergent. Do not use alcohol or any other solvents to clean the product. Ensure that the power supply has been turned OFF before cleaning the product.



1.

If you wish to mount the Neon tube LED to a wall follow these instructions.

Mark out the positions of where to place the clips on the wall, approximately 135 cm apart, each end of the tube. Attach the clips to the wall as image shows below. Ensure you use the correct type of wall plug and screw for the type of wall you are screwing into.

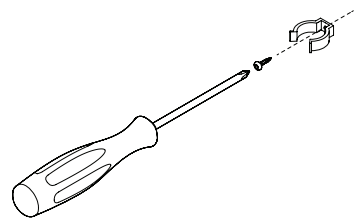

2.

Press the LED tube horizontally into the wall clips.

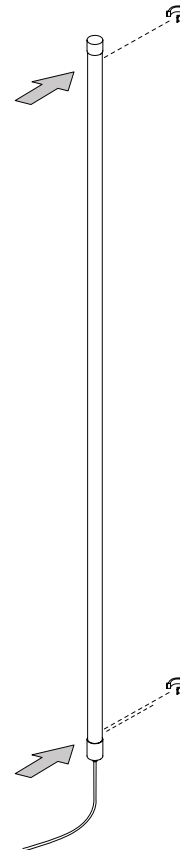

3.

If needed attach the correct adapter for your region. When attaching the UK adapter, open the lid and place the plug inside. See images below.

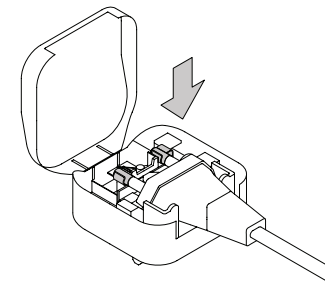
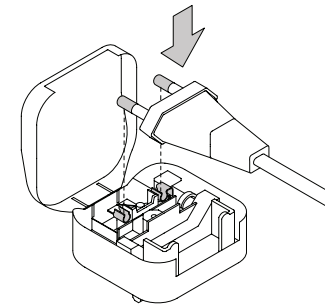

4.

Close the lid and tighten the screw in the middle of the adapter. Make sure the adapter is secure before use.

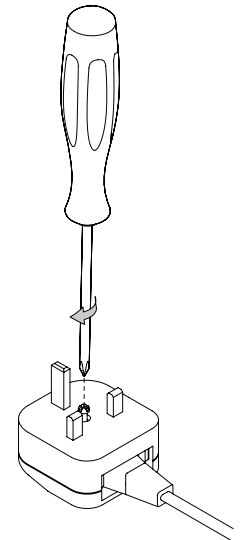
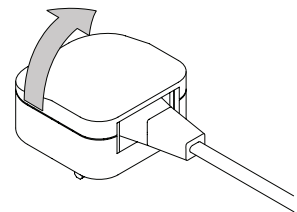

x2
screw



x2
wall clip

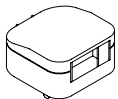

x1
UK converter



x1
LED tube with
cord and plug